

INTEGRA



VIAFLO Electronic Pipettes

Operating instructions

VOYAGER Adjustable Tip Spacing Pipettes



Declaration of conformity

INTEGRA Biosciences AG – 7205 Zizers, Switzerland

declares on its own responsibility that the devices

Description	Models
VIAFLO Pipettes	4011, 4012, 4013, 4014, 4015, 4016, 4621, 4622, 4623, 4624, 4626, 4631, 4632, 4633, 4634, 4636, 4641, 4642, 4646
VOYAGER Pipettes	4721, 4722, 4723, 4724, 4726, 4731, 4732, 4736, 4743, 4744, 4763, 4764

comply with:

EU Directives (DoW: Date of Withdrawal)	Before DoW	DoW	After DoW
Low Voltage Equipment	2006/95/EC	20.04.2016	2014/35/EU
Electromagnetic Compatibility	2004/108/EC	20.04.2016	2014/30/EU
Restriction of Hazardous Substances	2011/65/EU		
Waste Electrical and Electronic Equipment	2012/19/EU		
Battery Directive	2006/66/EC		

EU Regulations

Registration, Evaluation, Authorisation and Restriction of Chemicals (REACH)	1907/2006
Capacity Labelling of Portable Secondary Batteries	1103/2010

Standards for EU

Safety requirements for electrical equipment for measurement, control and laboratory use - General requirements.	EN 61010-1: 2010
Electrical equipment for measurement, control and laboratory use - EMC requirements.	EN 61326-1: 2013

Standards for Canada and USA

Safety requirements for electrical equipment for measurement, control and laboratory use - General requirements.	CAN/CSA-C22.2 No. 61010-1
Safety requirements for electrical equipment for measurement, control and laboratory use - General requirements.	UL 61010-1
Operation is subject to the following two conditions: (1) this device may not cause harmful interference, and (2) this device must accept any interference received, including interference that may cause undesired operation.	Part 15 of the FCC Rules Class A

International Standards

Piston-operated volumetric apparatus - Part 2: Piston pipettes	ISO 8655-2
--	-------------------

Zizers, March 12, 2018

 Elmar Morscher
 CEO



 Thomas Neher
 Quality Manager

Table of Contents

Chapter 1	Introduction	
1.1	Symbols used.....	7
1.2	Intended use.....	7
1.3	Safety notes	8
Chapter 2	Description of the device	
2.1	Scope of delivery	10
2.2	Overview of the VIAFLO/VOYAGER Electronic Pipettes	11
2.2.1	Pipette parts.....	11
2.2.2	Back view.....	12
2.2.3	Display	12
2.2.4	Touch wheel.....	13
2.2.5	Left and right arrow buttons	13
2.2.6	PURGE button	13
2.2.7	RUN key.....	13
2.2.8	Tip ejector	14
2.2.9	Reset button.....	14
Chapter 3	Installation	
3.1	Operating environment.....	15
3.2	Charging the battery	15
3.2.1	Charging the battery on a stand.....	16
3.2.2	Charging the battery with the mains adapter	16
3.3	Exchanging the battery.....	17
3.4	Toolbox - adapt your pipette.....	17
3.4.1	Preferences.....	18
3.4.2	Calibration & Service	20
3.4.3	Communications	21
3.4.4	Device Information	22
3.4.5	Language	22
3.4.6	Write protect.....	23

Chapter 4 Operation

4.1	Turn on/off the device	24
4.2	Attaching and removing GripTip pipette tips	24
4.3	Start pipetting	25
4.3.1	Pipetting	25
4.3.2	Blowout modes	25
4.3.3	Recommendations for pipetting	26
4.4	Pipetting options and settings	27
4.4.1	Edit option	27
4.4.2	Volume selection	27
4.4.3	Speed selection	28
4.4.4	Pace	29
4.4.5	Count, Mix Cycle and Rows	29
4.4.6	Help	29
4.5	VOYAGER tip spacing	30
4.5.1	Set the number of tip positions and the tip spacing	30
4.5.2	Tip spacing operation	30
4.5.3	Homing the tips	31
4.6	Troubleshooting/FAQ	32
4.6.1	General	32
4.6.2	Electronic	33

Chapter 5 Pipetting modes

5.1	Overview pipetting modes	34
5.2	Detailed description of pipetting modes	35
5.2.1	Pipet mode	35
5.2.2	Repeat dispense mode	36
5.2.3	Sample dilute mode	37
5.2.4	Pipet/Mix mode	38
5.2.5	Manual pipet mode	39
5.2.6	Reverse pipet mode	40
5.2.7	Variable dispense mode	41
5.2.8	Multi Aspirate mode	42
5.2.9	Sample Dilute/Mix mode	43
5.2.10	Serial Dilution mode	44
5.3	Custom step-based programming mode	45
5.3.1	Create a custom program	45
5.3.2	Modify existing programs	47
5.3.3	Example of custom mode	48

Chapter 6 Maintenance

6.1	Cleaning	49
6.2	Assembly and Disassembly	49
6.2.1	VIAFLO single channel lower end.....	49
6.2.2	VIAFLO multichannel pipettes	53
6.3	Sterilization	54
6.3.1	Autoclaving the disassembled components.....	54
6.4	Servicing.....	55
6.4.1	Shipping to INTEGRA Biosciences.....	55
6.4.2	Changing O-rings of tip fittings.....	55
6.4.3	Lubrication	56
6.5	Equipment disposal	56

Chapter 7 Calibration

7.1	Definitions.....	57
7.2	Materials.....	58
7.3	Preparation.....	58
7.3.1	Test conditions and environment.....	58
7.3.2	Cleaning.....	58
7.3.3	Firmware	58
7.3.4	Pre-wetting of tips	59
7.3.5	Leak test	59
7.4	Obtaining the Actual Volume	60
7.5	Calculation of accuracy and precision.....	61
7.6	Adjusting electronic pipettes.....	62

Chapter 8 Technical Data

8.1	Environmental conditions	64
8.2	Specification of the device.....	64
8.3	Pipetting speed.....	65
8.4	Intellectual Property.....	66
8.5	Pipette Specifications	67
8.6	Z Correction Factors.....	70

Chapter 9 Accessories

9.1	Accessories	71
9.2	Consumables	72

Imprint

© 2018 INTEGRA Biosciences AG

All rights to this documentation are reserved. In particular the rights of reproduction, processing, translation and the form of presentation lie with INTEGRA Biosciences AG. Neither the complete documentation nor parts thereof may be reproduced in any way, or stored and processed using electronic media or distributed in any other way without the written consent of INTEGRA Biosciences AG.

This operating instruction manual has part number 161950, the version is V09. It applies as of (see Toolbox - Device information):

Serial number	7000000 or higher
(Firmware) FW version	4.15 or higher

of VIAFLO/VOYAGER Electronic Pipettes until a newer revision is released.

VIAFLO, VOYAGER, VIALINK, and GripTip are trademarks of INTEGRA Holding, Switzerland.

Manufacturer

INTEGRA Biosciences AG

CH-7205 Zizers, Switzerland

T +41 81 286 95 30

F +41 81 286 95 33

info@integra-biosciences.com

www.integra-biosciences.com

INTEGRA Biosciences Corp.

Hudson, NH 03051, USA

T +1 603 578 5800

F +1 603 577 5529

Customer service

Please contact your local INTEGRA Biosciences representative.

To find out name and address go to www.integra-biosciences.com.

Further information and operating instructions in other languages are available on www.integra-biosciences.com or on request info@integra-biosciences.com.

1 Introduction

These operating instructions contain all the information required for installation, operation and maintenance of the VIAFLO/VOYAGER Electronic Pipettes. This chapter informs about the symbols used in these operating instructions, the intended use of the pipettes and the general safety instructions.

1.1 Symbols used

The operating instructions specifically advise of residual risks with the following symbols:

**WARNING**

This safety symbol warns against hazards that could result in injury. It also indicates hazards for machinery, materials and the environment. It is essential that you follow the corresponding precautions.

**CAUTION**

This symbol cautions against potential material damage or the loss of data in a microprocessor controller. Follow the instructions.

**NOTE**

This symbol identifies important notes regarding the correct operation of the device and labor-saving features.

1.2 Intended use

This is a general-purpose laboratory instrument for use in research only. Any use of this instrument in a medical or IVD setting is under the sole responsibility of the user.

If the VIAFLO/VOYAGER Electronic Pipettes are used in a manner not specified by INTEGRA Biosciences, the protection provided by the VIAFLO/VOYAGER Electronic Pipettes may be impaired.

VIAFLO/VOYAGER Electronic Pipettes are microprocessor controlled and stepper motor driven pipettes. They are used for aspirating and dispensing aqueous liquids in the volume range of 0.5–5000 µl using GripTip pipette tips. In addition, the VOYAGER adjustable tip spacing pipettes enable users to transfer multiple samples simultaneously between different labware.

1.3 Safety notes

VIAFLO/VOYAGER Electronic Pipettes comply to the recognized safety regulations and are safe to operate. The pipettes should only be operated when in perfect condition and while observing these operating instructions.

The device may be associated with residual risks if it is used or operated improperly by untrained personnel. Any person operating the pipettes must have read and understood these operating instructions, and particularly, the safety notes, or must have been instructed by supervisors so that safe operation of the device is guaranteed.



WARNING

- Use only an original INTEGRA Li-ion battery (#4205) and charging device.
- *Old Li-ion batteries may cause a safety risk. We recommend to replace the battery after 3 years of use. Also replace the battery if the charging intervals are unusually short or if the charging takes much longer than usual (4 hours or more). – These are indicators that the battery has reached the end of its life-cycle.*
- *Li-ion technology bears the risk of thermal runaway and cell rupture if the battery was damaged. Do not expose the battery to heat (> 60 °C) and avoid mechanical stress. Batteries which were subject to deep discharges may develop internal short circuits, leading to an increased self-discharge rate and heating during battery charging. This may also result in thermal runaway and cell rupture.*



CAUTION

- *To extend the battery life-cycle, it is recommended to charge the battery every 2 months if the pipette is not used regularly. If the pipette is not used for more than 6 months, unplug the battery.*



WARNING

- *Do not use the VIAFLO/VOYAGER Electronic Pipettes near flammable material or in explosive areas. Also, do not pipette highly flammable liquids such as acetone or ether.*
- *When handling dangerous substances, comply with the material safety data sheet (MSDS) and with all safety guidelines such as the use of protective clothing and safety goggles.*

**CAUTION**

- Do not immerse the VIAFLO/VOYAGER Electronic Pipettes in liquid. The fluid can damage internal parts. Avoid pipetting of liquids whose vapors could attack the materials PA (polyamide), POM (polyoxymethylene), FPM (fluor-rubber), NBR (nitrile-rubber), CR (chloroprene), silicone. Corrosive vapors could also damage metallic parts inside the device.
- Do not modify the VIAFLO/VOYAGER Electronic Pipettes in any way. Repairs may only be performed by INTEGRA Biosciences or by an authorized after-sales service member.
- Parts may be replaced with original INTEGRA Biosciences parts only.

**NOTE**

Prolonged exposure of the VIAFLO/VOYAGER Electronic Pipettes to UV-light can cause discoloration and/or yellowing of the pipette housing. However, this will not affect the performance of the device in any way.

Regardless of the listed safety notes, additional applicable regulations and guidelines of trade associations, health authorities, trade supervisory offices, etc. must be observed.

Please visit our website www.integra-biosciences.com on a regular basis for up to date information regarding REACH classified chemicals contained in our products.

2 Description of the device

2.1 Scope of delivery

- VIAFLO or VOYAGER pipette
- Rechargeable battery (located inside the pipette, Li-ion, 3.7 V, 1050 mAh)
- Bag of spare O-rings (300 µl and 1250 µl volume ranges only)
- O-ring removal tool (300 µl and 1250 µl volume ranges only)
- Certificate of Performance

**CAUTION**

Verify the scope of delivery when unpacking the device and check for potential transportation damage. Do not operate a device that is damaged, instead contact your local dealer.

2.2 Overview of the VIAFLO/VOYAGER Electronic Pipettes

2.2.1 Pipette parts



- 1 **Display**
- 2 **Back Button**, to navigate backward
- 3 **Touch Wheel**, spin to scroll and move the cursor
- 4 **OK Button**, to make a selection
- 5 **Left and Right Arrow Buttons**, for selections
- 6 **PURGE Button**, to empty tips
- 7 **RUN Key**, to start operations
- 8 **Tip Ejector**
- 9 **Finger Hook**, facilitates easy operation
- 10 **Volume Indicator Label**, color matches GripTip box insert.
- 11 **Ejector Sleeve**
- 12 **Tip Fitting**

2.2.2 Back view

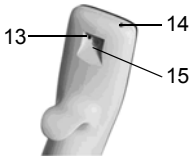

- 13 **Reset Button**
- 14 **Power Connector**
- 15 **Charging Stand Interface**

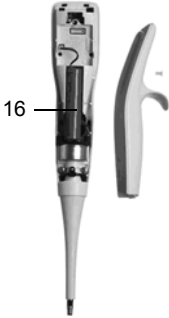

- 16 **Battery**

2.2.3 Display

The Display shows all pipetting options.

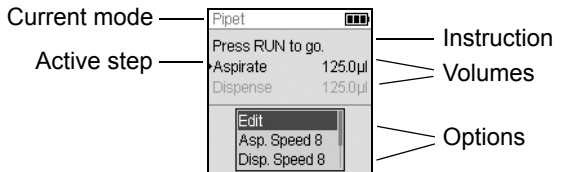
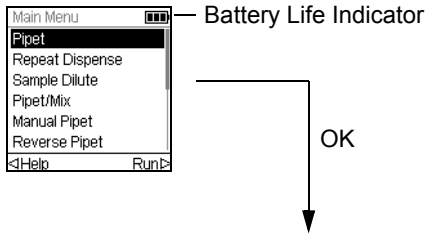

2.2.4 Touch wheel

The **Touch Wheel** is fully operational with only one hand. Rotational finger movements translate into up and down cursor movement on the display. The **Touch Wheel** is fully functional with the use of latex gloves.

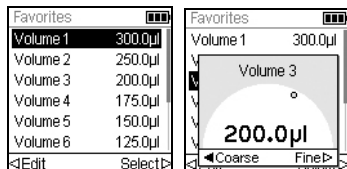

Move finger on the **Touch Wheel** to choose (and highlight) an option on the display. Press **OK** (4) to make the selection.

When a setting dial is displayed, spin the **Touch Wheel** to change the value and press **OK**.

2.2.5 Left and right arrow buttons

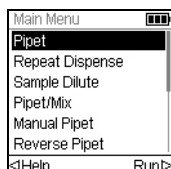

At times, you will see ◀ and ▶ on a display screen. These buttons are used to select options.

Press ◀ to select the option indicated with the left arrow (HELP, in the example beside). Press ▶ to select the option indicated with the right arrow (RUN, in the example).

On VOYAGER pipettes, these buttons are also used for tip spacing adjustments.

2.2.6 PURGE button

During pipetting, you can interrupt the current pipetting protocol and purge all remaining liquid currently in the GripTips. To do so, press **PURGE** (6).



The pipette will display a prompt:

To proceed, press and release the **RUN Key** (7). Upon completion of the dispense, the first step in the current program will be displayed.

2.2.7 RUN key

Press and release the **RUN Key** (7) to initiate aspiration, dispense, mix, purge, and special pipetting operations. This button is centrally located for left- or right-handed actuation.

During dispense, you can press and hold the **RUN Key** to perform a two-step blowout, see “4.3.2 Blowout modes” on page 25.

2.2.8 Tip ejector

The **Tip Ejector** easily ejects tips from the tip fitting.



The serial number can be found beneath the tip ejector. Press and hold the tip ejector in the down position to see the 7-digit serial number.

2.2.9 Reset button

The **Reset Button** (13) is located on the back of the pipettes. It is used to reset the RAM in the pipette. The programs stored in memory are maintained. Once pressed, the startup screen will be displayed.

Press any key to continue and allow the instrument to initialize and home. The routine ends by displaying the Main Menu.

3 Installation

3.1 Operating environment

The VIAFLO/VOYAGER Electronic Pipettes have been designed for use in a laboratory. They shall be operated in a dry and dust-free location with a temperature of 5–40 °C and a maximal (non-condensing) relative humidity of 80 %.

3.2 Charging the battery

All VIAFLO/VOYAGER Electronic Pipettes share the same rechargeable Li-ion battery. Charge the battery completely before first use. A full charge takes 2.5 hours (max. 4 hours) and will provide approximately 3000 pipetting cycles for single channel pipettes and 1500 cycles for multichannel pipettes.

**CAUTION**

To extend the battery life-cycle, it is recommended to charge the battery every 2 months if the pipette is not used regularly. If the pipette is not used for more than 6 months, unplug the battery.

A battery indicator is provided on the pipette display (2.2.3) indicating different states:

- Blinking red icon: Battery is low and needs to be recharged. If not connected to the mains adapter, the pipette will turn off soon.
- Green icon: Pipette is connected to the mains adapter.
- Blinking bars: Pipette is recharging.
- Two static and one blinking bar on the right: Pipette is recharging and battery is 80% charged.
- Three static bars: Battery is fully charged.

**CAUTION**

Use only the approved INTEGRA battery, mains adapter or charging stand, see (“9.1 Accessories” on page 71). Use of an incompatible power transformer can damage the pipette.

3.2.1 Charging the battery on a stand

Use one of the different charging stands (#4210, #4211, #4215, #3215 with #3217 or #3218, see “9.1 Accessories” on page 71) - to charge the battery.



Place the pipette on the charging stand by fitting the power receptacle (15, on the top back of the pipette) over the prong connector on the top of the stand.

Plug the cable of the adequate power supply to the socket.



CAUTION

Always use the correct mains adapter for the charging stand.

The pipette will turn on when placed on the stand and turn off when the Turn Off Time is reached, also see [3.2.2](#). For disconnecting simply lift the pipette up from the stand.

3.2.2 Charging the battery with the mains adapter

With the optional mains adapter (#4200), you can use the pipette while charging through the line cord.



Insert the mains adapter connector into the receptacle on the top back of the pipette (14). Plug the mains adapter into a wall outlet.

The pipette will turn on when the line cord is connected.

If the pipette is idle while charging, the display may dim or show the start up screen (see “4.1 Turn on/off the device” on page 24), but it will continue to show the battery life indicator. When the Standby Time is reached, the display is turned off. When the Turn Off Time is reached, the instrument will shut off.

3.3 Exchanging the battery



To exchange the battery, loosen the screw to detach the pipette backing. Disconnect the power plug of battery (16). Connect the power plug of the new battery to the pipette's socket and reassemble the pipette backing.

After exchanging the battery, a protective switch is active. The pipette can only be started after connecting it to the mains power supply.



WARNING

INTEGRA VIAFLO/VOYAGER Electronic Pipettes use Li-ion batteries, see "1.3 Safety notes" on page 8.

3.4 Toolbox - adapt your pipette

The Toolbox provides options to adapt the device to appropriate applications, setting personal preferences, calibration, computer connectivity and storing device information.

Toolbox mode	Description
ASSIST	Additional pipetting modes available in combination with ASSIST (hidden by default, see Preferences - Main Menu).
ASSIST PLUS	Additional pipetting modes available in combination with ASSIST PLUS (hidden by default, see Preferences - Main Menu).
Preferences	Customizes the system parameters.
Calibration & Service	Sets calibration and service history options.
Communications	Enables communication between your electronic pipette and a PC.
Device Information	View your pipette's serial number and set a personal ID.
Language	Sets language.
Write Protect	Protects programs or menu options from modification.
Time/Date	Sets current time and date.

Help information is available for each mode.

3.4.1 Preferences

Preferences customizes your system parameters. Select a preference and press **OK** to access.

Preference	Description	Range
Sound	<p>Simple tones indicate completion of operations and errors. Select an option and press OK to change the status of the beep tone between On and Off:</p> <ul style="list-style-type: none"> • Step Complete: At the end of a program step • Program Complete: At program completion • Purge Key: When Purge is pressed. • Messages: When a message appears. • Error Message: When an error message appears or when illegal data entry is attempted. • Touch Wheel: When using the Touch Wheel. • Last Dispense: Before the last dispense in Repeat Dispense and Variable Dispense. 	<p>✓/* (On/Off)</p>
Display	<p>Customizes your display. Press OK to select an option, use the Touch Wheel to display the desired value.</p> <ul style="list-style-type: none"> • Start up Screen: Select the startup display at one of the following: None or Custom (up to two, uploaded with VIALINK). Press ▷ to save your selection. • Brightness: Use the Touch Wheel to change the brightness: 1 (dim) to 10 (bright). Press OK. • Dim Time: The display will dim after a set number of minutes. A shorter dim time helps preserve battery life. Press OK to save your selection. • Standby Time: The display will turn off after a set number of minutes and allows you to continue working where you have left. A shorter standby time helps preserve battery life. • Turn Off Time: The pipette will turn off after a set number of hours. You can change this setting. Press OK to save your selection. 	<p>None, Custom 1 or 2</p> <p>1-10</p> <p>Never, 1-20 min</p> <p>5-60 min (default 5 min)</p> <p>1-24 hours (default 8 h)</p>
Main Menu	<p>Select a function to be hidden from the main menu (Off) and press OK, e.g. ASSIST, Pipet, Repeat Dispense, Sample Dilute, Pipet/Mix, Tip spacing.</p>	<p>✓/* (On/Off)</p>
Touch Wheel	<p>Adjust your Touch Wheel sensitivity. Press ▷ to save.</p>	<p>Low, Medium, High</p>

Preference	Description	Range
Pipetting	<p>Select an option and press OK.</p> <ul style="list-style-type: none"> • Purge Key Speed: Choose the desired purge speed and press OK to save your selection. • Blowin Delay: Choose a timed delay between the blowout and the blowin (delay before the piston homes) at the end of a dispense, if no two step blowout is performed, see “4.3.2 Blowout modes” on page 25. • Extend Volume: For pipetting below or above the specified volume range: 50 µl pipette: (1.0)–2–50 µl 125 µl pipette: (2.0)–5–125 µl 300 µl pipette: (5.0)–10–300–(310) µl 1250 µl pipette: (25)–50–1250 µl The volumes in brackets refer to extended volumes, e.g. extend the minimal pipetting volume on a 125 µl pipette from 5 µl to 2 µl. Not available for 12.5 µl and 5000 µl pipettes. • Speed Table: Adapts the speed steps 1-10 to user defined pipetting speeds in µl/s. Select a speed step, press OK and use the Touch Wheel to change the value. Press OK and save your selections. • Pace in Custom: Allows for continuous dispensing by pressing and holding the RUN Key during consecutive dispenses. To activate this feature, set the time gap between dispenses. 	<p>1-10</p> <p>None/ 0.5-5.0 s</p> <p>✓/* (On/Off)</p> <p>µl/s values depend on pipette size</p> <p>None/1-10 (slow-fast)</p>
Communication Menu	Select the communication to be shown under communications (✓, On) and press OK , e.g. Bluetooth, USB, Via ASSIST.	✓/* (On/Off)

After changing desired settings, press ► to save.



NOTE

Extending the volume range is not recommended. Full functionality and specified accuracy/precision cannot be guaranteed.

The default values of the speed table are optimized for the pipette motor. Changing the values may cause a more noisy operation of the pipette but does not do harm to the pipette.

3.4.2 Calibration & Service

These options enable you to set calibration features, review service history and check the number of pipetting moves performed.

Calibration & Service	Description	Range
Calibration	<p>Allows for re-calibration of the pipette to restore accuracy. The calibration factors for Pipette and Repeat type are displayed.</p> <p>To edit the calibration volumes, press ◀ Edit.</p> <ul style="list-style-type: none"> • Target Volume: This is the volume you are interested in using for the calibration. • Actual Volume: This is the measured volume obtained when dispensing the target volume. • Current Factor: Displays the factor currently in use. • Factory Reset: Resets the correction factor back to the original factory setting. Press ◀ to apply the factory setting. 	-
Calibration Reminder	<p>Sets a calibration reminder based on a specified time frame or number of pipetting cycles. When the calibration reminder is displayed, press any key to confirm. However, the reminder will reappear every time the pipette is turned on until you change the reminder time or use the reset option.</p> <ul style="list-style-type: none"> • Reminder: Press OK to turn the reminder timer On or Off. • Days/Cycles: Use the Touch Wheel to set a reminder interval for calibration (time in days or in thousands of cycles). Press ◀ to set the timer to the defined calibration interval. • Remind in/Total Cycles: Displays the residual time or amount of cycles respectively before calibration is required. • Reset: Resets the timer to the defined calibration interval. Press ◀ to enable. <p>Press ▶ to save.</p>	✓/* (On/Off) 1-365 days or 1k - 240k cycles
Time or Cycles		
Service History	<p>Displays notes of any service that took place on the pipette listed newest entry first.</p>	-

Calibration & Service	Description	Range
Move Counter	Displays the number of completed moves. <ul style="list-style-type: none"> • Piston Moves: One piston move is defined as one full start and stop cycle of the piston. • Spacing Moves (VOYAGER only): One tip spacing move is defined as one full start and stop cycle of the spacing motor. 	-

After changing desired settings, press \triangleright to save.

3.4.3 Communications

The VIAFLO/VOYAGER Electronic Pipettes can be programmed from a PC via a Charging/Communication Stand (#4211), Charging/Communication Station for Linear Stand (#3218) or via wireless Bluetooth connection.

VIALINK is a pipette management software for the PC. It allows the user to upload/download custom programs, images, firmware updates and service history to and from VIAFLO/VOYAGER Electronic Pipettes. It can be downloaded from the INTEGRA website in the product section. A detailed description of the software, along with the operating instructions, can be found on the website as well.

Communications	Description
USB	Place the pipette on a Charging/Communication Stand (#4211) and connect it to the USB port of your PC. To exit the communications mode follow screen prompt or press the disconnect button in VIALINK.
Bluetooth	Each pipette needs its own Bluetooth module (#4221). Bluetooth communication has an open field connectivity of about 10 meters. If a pairing code is required: 12345.
Via ASSIST	Activate this communication for live position teaching on ASSIST or ASSIST PLUS.
Remote Ctrl (Bluetooth)	To control the pipette by an external device via Bluetooth, e. g. to integrate the pipette in an automation system.
Remote Ctrl (Wire)	To control the pipette by an external device, e. g. to integrate the pipette in an automation system.

Select one connection type and press **OK** to allow communication with the PC. VIALINK will detect the pipette automatically.

3.4.4 Device Information

This menu displays information about your pipette, such as pipette size, number of channels, serial number, firmware (FW) and hardware (HW) version.

Device Information	Description
Edit Owner	<ul style="list-style-type: none"> Press ◀ Edit Owner to enter the user name for your pipette. Use the Touch Wheel to highlight a character and press OK. You can press ◀ to Delete the last character entered. After entering the desired text, press ▶ to Save.

Go to the next pages with Next ▶.

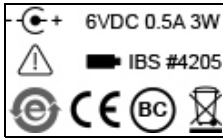

The last page displays the compliance screen, which is also shown during start up. It lists the standards the pipettes comply with.

3.4.5 Language

Language	Description
Language	You can choose the language in which all screens are displayed. Scroll to the desired language, press OK and ▶ to Save.

3.4.6 Write protect

Select this option to protect programs and menu options from inadvertent modification. The pipetting programs can still be used.

Write Protect	Description	Range
	Select an option and press OK to switch protection on or off: <ul style="list-style-type: none"> • Standard Programs • Custom Programs • Calibration • Toolbox • Tip Spacing (VOYAGER only) • Password Protection: Protect the access to the write protect menu by selecting “✓”. • Edit Password, if password protect is switched on. To enter a password use the Touch Wheel to highlight a character and press OK. Press ▷ to save the password. The password must be entered before you can access the write protect menu. 	✓/✕ On/Off

Keep the password in a safe place. Should you lose your password, contact INTEGRA Biosciences for assistance in retrieving it.

4 Operation

4.1 Turn on/off the device

Turn on:

Press and release the **RUN Key** (7) to turn on the pipette.



CAUTION

Do not touch the touch wheel at switch on and during homing, because it is calibrated during the start up process. Make sure the tip fittings (12) of the VOYAGER pipette are free of any obstacles when it is switched on.

The pipette flashes the startup screen and performs a full motor homing routine, ensuring the motor is in the run position. “Home” is the base point for the pipette. Homing is the process whereby the pipette motor moves the piston(s) to a sensor position. This position ensures that no liquid remains in the tips. For the VOYAGER, homing also includes the tip spacing motor. The tips move to the first tip spacing position. After homing the Main menu is displayed.

Turn off:

To turn off the pipette, press and hold the **Back Button** (2) for 3 seconds.



NOTE

The Pipette will dim and turn off automatically after a preset duration of inactivity. This duration is 5 minutes, by default, and configurable with the Toolbox (see “3.4.1 Preferences” on page 18).

4.2 Attaching and removing GripTip pipette tips



CAUTION

To ensure optimal performance of your VIAFLO/VOYAGER Electronic Pipettes always use appropriate GripTips, see “9.2 Consumables” on page 72.

The unique GripTip system of INTEGRA pipettes reduces attachment and ejection forces, ensures a perfect fitting to prevent the tips from falling off and to provide a perfect seal. On a multichannel pipette all tips sit on the same height.



A rim inside the GripTips snaps over the multi-lobes and ensures firm attachment of the tips.

A shoulder provides a positive stop to prevent over-tightening of the tips. Without hammering, the tip is either on or off but nothing in between.

The O-ring provides a forgiving and robust seal surface for the pipet tip.

Attach the tips:

When loading tip(s), press the pipette into the appropriate GripTip(s) until you hear and feel a click indicating that a seal has been achieved. Once you feel the click, stop applying pressure. When loading GripTip pipette tips on a multichannel pipette, slowly rock the pipette from one side to the other side to ensure the proper seal is achieved.

Discard your used tips:

If liquid is in the tips, empty them by pressing the **PURGE Button (6)**. Tips are easily ejected by pressing the **Tip Ejector (8)**.

4.3 Start pipetting**4.3.1 Pipetting**

Use the **Touch Wheel (3)** to scroll to your desired pipetting mode and press **OK (4)**. Selected parameters for the action you are about to perform will be displayed on the Run screen.

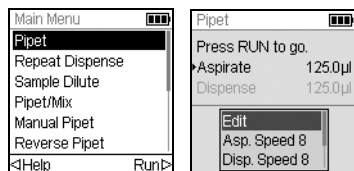

Insert the tips into the liquid to be transferred. Press and release the **RUN Key (7)** to aspirate the volume selected in the first step of your protocol (shown on the Run screen).

To execute subsequent steps, press the **RUN Key**.

For a detailed description see [“5.2 Detailed description of pipetting modes”](#) on page 35. You can change the parameters of your pipetting mode at any time, see the following sections.

4.3.2 Blowout modes

During the last dispense of a program, a blowout is performed automatically. Liquid may be aspirated back into the tips when the pistons move back to the home position, a process called blowin. There are two ways to perform the blowout/blowin routine:

- **Automatic blowout:** Pressing (and releasing) the **RUN Key** starts the dispense with automatic blowout and blowin. You can choose a timed delay between the blowout and the blowin, see [“Pipetting - Delayed blowin”](#) under [“3.4.1 Preferences”](#) on page 18.
- **Automatic two-step blowout:** Perform a two-step blowout to manually delay the blowin:
 - Press and hold the **RUN Key** to start dispense with blowout.
 - Remove the tips from the target vessel.
 - Release the **RUN Key** to start blowin.

4.3.3 Recommendations for pipetting

INTEGRA Biosciences recommends the following techniques for enhancing pipetting results. These techniques are consistent with ISO standard 8655-2.

- It is best to immerse the GripTips just enough in liquid (2–3 mm) to allow the desired volume to be aspirated.
- Always prewet GripTips. After loading tips onto your pipette, aspirate and dispense the full volume 2-3 times to coat the inside of pipet tips. Pre-wetting ensures that the liquid and air inside the tips are at equal temperature and the dead air space is humidified.
- VIAFLO/VOYAGER Electronic Pipettes are air displacement pipettes. To properly dispense liquids, ensure that the pipette tip is at a 0–20° angle against the wall of the container or well. After dispense you must touch GripTips against wall or dip them into the liquid after a dispense. This process is referred to as “touching off” or “tip touch” and prevents liquid from clinging to the pipette tips.
- In programs such as Repeat Dispense, a pre- and post-dispense can be programmed. These two dispenses are not used and are dispensed into the waste as they contain the accumulated pipetting errors. Using a pre- and post-dispense is recommended if accuracy and precision are of high importance.
- Viscous samples should be aspirated and dispensed at the slowest speeds to ensure accurate pipetting. In addition, the pipetting mode “Reverse pipet” can be used to optimize pipetting results with viscous samples.
- For pipetting liquids with high vapor pressures (such as methanol or ethanol), use relatively fast pipetting speeds and avoid prolonged pauses after aspiration.
- Calibrate based on fluid type. VIAFLO/VOYAGER Electronic Pipettes are tested and calibrated at the factory for use with distilled water at room temperature. It may be necessary to re-calibrate your pipettes if the liquid to be used has different physical properties (specific gravity and vapor pressure) than water. Calibration mode can be accessed in the Toolbox menu.
- VIAFLO/VOYAGER Electronic Pipettes are not calibrated out of the factory below 10% of their maximum volume. While it is possible to pipette below 10% of the maximum volume, it may lead to an undesirable precision and accuracy result. Therefore, if accuracy and precision are critical, it is recommended to work above 10% of the pipette’s maximum volume.



WARNING

Avoid pipetting for extended periods. To minimize the risk of repetitive strain injury, include pauses of several minutes.

4.4 Pipetting options and settings

4.4.1 Edit option

The Edit option is available for each mode. It enables you to access the variables that you can adjust for a pipetting mode. These variables include Speed, Volume, Pace, Count, Mix Cycles, Rows, Direction and Tip Spacing (VOYAGER).

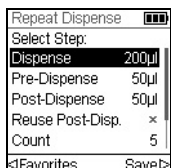
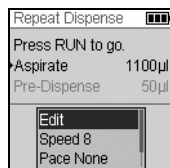

Select a pipetting mode. Then, select Edit on the list of options and press **OK**. A list of associated steps is displayed. For example, if selecting Edit on the Repeat Dispense screen, the modifiable steps associated with Repeat Dispense are displayed.

4.4.2 Volume selection

To change a volume select the Edit option and press **OK**. The adjustable volumes are displayed.



Use the **Touch Wheel** to highlight the volume you want to change (Aspirate, Dispense, Mix, or Air Gap). Press **OK** and a Volume setting “dial” is displayed.

Use the **Touch Wheel** to change the volume. Press **OK** to confirm your volume selection and **▷** to save.



NOTE

Use the **Arrow Buttons** to change the volume in coarse or fine increments. Select **COARSE** (with **◀**) to change the volume in larger increments. Select **FINE** (with **▶**) to change the volume in smaller increments. The increment sizes vary based on the pipette volume range, as shown under “8.5 Pipette Specifications” on page 67.

Define and select favorite volumes

You can define, save, and select up to ten favorite volumes for quick access. These volumes can only be within the pipette volume range.

There are two ways to access and customize the list of favorite volumes:

- When in Pipet mode, use the **Touch Wheel** to highlight Favorites and press **OK**.
- When in other modes, select the Edit option and press **OK**. The steps with volumes to be adjusted are displayed. Use the **Touch Wheel** to highlight the desired volume and press **◀ Favorites** to display the list of favorite volumes.

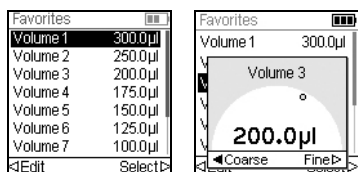

Use the **Touch Wheel** to highlight the desired volume and press **▷ Select**. Alternatively, modify a volume by pressing **◁ Edit**.

Save your setting **▷**.

4.4.3 Speed selection

The speed option controls the speed at which liquid is aspirated, dispensed, or mixed in each mode. Speed can be set as a value from 1 (slowest) to 10 (fastest), see also “[8.3 Pipetting speed](#)” on page 65.

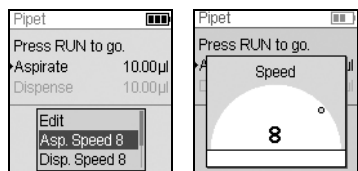

When in any pipetting mode, use the **Touch Wheel** to highlight the Speed option and press **OK**. Select the speed and press **OK** to save your setting.

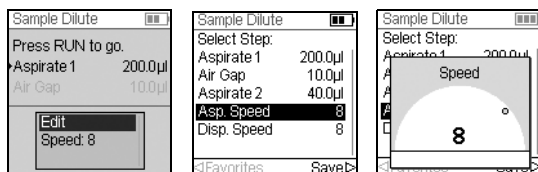

Speed may be changed in most Edit menus. Scroll to the Speed and press **OK**. Choose the speed, press **OK**, and press **▷** to save your selection.

The speeds selected in each mode (i.e., Pipet, Repeat Dispense, etc.) are stored for that mode only.

Speeds can be set independently for each operation (Aspirate, Dispense, Mix).



NOTE

Viscous samples should be aspirated and dispensed at the slowest speeds to ensure accurate pipetting.

To dispense liquids with low viscosity and high vapor pressure, such as ethanol, use relative fast pipetting speeds and avoid prolonged pauses for aspiration.

4.4.4 Pace

The Pace option sets the time gap between dispenses in repeat pipetting. Pace is used in the Repeat Dispense and Variable Dispense modes. While you press and hold the **RUN Key**, the pipette will dispense multiple programmed volumes with the selected pace. Release the **RUN Key** to stop the paced dispense. Press **RUN** to continue dispensing.

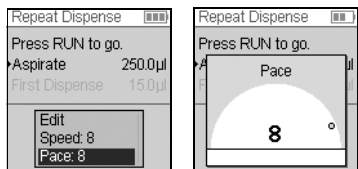

Use the **Touch Wheel** to select the desired Pace option and press **OK**.

Select the pace, from None, 1 (slowest) to 9 (fastest).

Press **OK** to save your setting.

4.4.5 Count, Mix Cycle and Rows

The Count, Mix Cycle, and Rows steps are used in various modes, see [“5.2 Detailed description of pipetting modes”](#) on page 35. Each is accessed with the Edit option. Use the **Touch Wheel** to highlight the step and press **OK**.

Count sets the number of dispensing steps. Mix Cycle sets the number of mixes. In serial dilution mode, rows sets the number of columns. A column indicator will notify the number of dilutions performed. Columns (first number) and Mix Cycles (second number) are tracked on the display. Mix Cycles are shown in red when mixing. A black triangle on the column number indicates the active program step.

Select a desired value. Press **OK** and then press **▷** to save your setting(s).

4.4.6 Help

The Help information available for each mode describes the mode operation.

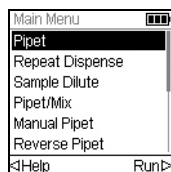

While in the Main menu, highlight a pipet mode, then press **<** to select the Help option.

4.5 VOYAGER tip spacing

The VOYAGER pipettes provides you with the ability to vary tip spacing. The spacing is expressed in millimeters and represents the distance between adjacent tips.

4.5.1 Set the number of tip positions and the tip spacing

It is possible to set two or three tip spacing positions.



Use the touch wheel to highlight Tip Spacing on the Main Menu. Press **OK**. The tip spacing menu displays:

- The number of tip positions the VOYAGER will move to (2 or 3).
- The First, Middle, and Last positions.
- The current spacing that the tips are in.

To change the number of tip positions to move between, use the touch wheel to scroll to Positions. Press **OK** to toggle between 2 or 3 positions. Press **>** to Save this selection. If 2 positions are chosen, the Middle position is grayed out.



To change a tip spacing, use the touch wheel to select either the first, middle or last position. Press **OK** and the Set Spacing menu appears.

Press **<** Close to reduce or **Open >** to increase the tip spacing incrementally. The tips will physically move allowing you to visually match the tip spacing to the target vessels. When the desired tip spacing is reached, press **OK**.

Make the desired changes to all positions. Upon completion, press **>** to Save all the selections.

4.5.2 Tip spacing operation

Select the pipetting function of interest (Pipet, Repeat Dispense, Sample Dilute, etc.). The bottom of the screen displays the tip spacings which are currently available. The current position is highlighted.



The First, Middle, and Last position are displayed from left to right.

In the adjacent figure, 4.5 mm is the First position, 6.5 mm is the Middle position, and 9.0 mm is the Last position. The current position is highlighted.

Press **<** or **>** to move the tips to the next position.

The tip spacing can be changed at any step in the program.

4.5.3 Homing the tips

Homing the tips may be necessary if the tip spacing motor was restricted from achieving its proper position. Every time the pipette is turned on, the tip spacing motor homes and moves to the first tip spacing position.

Tip Spacing	
Positions:	3
First:	9.0mm
Middle:	11.5mm
Last:	14.0mm
Spacing: 9.0mm	
< Home Tips	Save >

You may also home the tip spacing motor when needed.
To do so, press < Home Tips on the Tip Spacing menu.

4.6 Troubleshooting/FAQ

4.6.1 General

Problem	Probable cause	Remedy
Leakage.	<ul style="list-style-type: none"> • Tip incorrectly attached. • Foreign particles between tip and tip fitting. • Damaged red O-ring. 	<ul style="list-style-type: none"> • Attach a new tip. • Clean tip fitting. Attach new tips. • Change the red O-ring, see 6.4.2. • If leak persists, contact service.
Dispense results are inaccurate.	<ul style="list-style-type: none"> • Unsuitable calibration. • Improper pipetting techniques. 	<ul style="list-style-type: none"> • Recalibrate with the liquids in question. • Adjust aspiration and dispense speed depending on liquid: <ul style="list-style-type: none"> - High viscosity liquids may require calibration. - High vapor pressure liquids may require pre-wetting. - Refer to proper pipetting techniques section 4.3.3
Not dispensing/ aspirating.	<ul style="list-style-type: none"> • Piston stuck or not connected. • Motor not running. • Internal O-ring is damaged. 	<ul style="list-style-type: none"> • Contact service.
Droplets on the tips.	<ul style="list-style-type: none"> • Temperature of liquid differs from that of air inside the tips. • Liquid of low viscosity and high vapor pressure. • Touch off was not performed. 	<ul style="list-style-type: none"> • Pre-wet tips up to 3 times. • Increase dispensing speed. • Perform a touch-off (mandatory in Repeat Dispense and Variable Dispense mode).
Software does not react.	<ul style="list-style-type: none"> • Software frozen. 	<ul style="list-style-type: none"> • Press Reset Button on back of the pipette.

4.6.2 Electronic

Problem	Probable cause	Remedy
When pressing RUN, a “Low Battery” message appears on the Run screen.	<ul style="list-style-type: none"> • Low battery. 	<ul style="list-style-type: none"> • Re-charge the battery in order to resume pipetting operation.
Display turns off completely.	<ul style="list-style-type: none"> • Dead battery. 	<ul style="list-style-type: none"> • Charge the battery with a power cord or charge stand. • Replace the battery after 3 years.
Touchwheel response is erratic and uncontrollable.	<ul style="list-style-type: none"> • A finger was on the touchwheel when the pipette was turned on. 	<ul style="list-style-type: none"> • Reset the pipette without touching the touchwheel during reset. • Adjust the touchwheel sensitivity with Toolbox, Preferences, Touch Wheel, see 3.4.1.
Displayed characters are scrambled.	<ul style="list-style-type: none"> • Unknown. 	<ul style="list-style-type: none"> • Reset the pipette.
Battery charging indicator is not pulsing while on the stand. Pipette does not turn on when placed on the charging stand.	<ul style="list-style-type: none"> • Charge stand pins are out of place. 	<ul style="list-style-type: none"> • Check that both charge stand conductor pins are at the same height. • Make sure the charger is plugged in.
Error message “Homing error!” is displayed.	<ul style="list-style-type: none"> • Indicates too much friction was encountered during operation. • Indicates possible motor failure. 	<ul style="list-style-type: none"> • Reset the pipette. • If problem persists, please contact service for technical assistance.
Tip spacing motor not working.	<ul style="list-style-type: none"> • Tip spacing motor drive not initialized. 	<ul style="list-style-type: none"> • Reset the pipette. • Turn pipette off. Unplug battery for about 5 seconds. Turn pipette on.

5 Pipetting modes

This chapter describes how to set up programs on the VIAFLO/VOYAGER Electronic Pipettes in two ways:

- **Function-based pipetting modes:** You can select from ten predefined pipetting modes that you can quickly and easily edit and execute. They are described in the following sections.
- **Custom step-based programming mode:** You can create and store up to forty multi-stepped pipetting protocols on the pipette using the basic functions of “Aspirate, Dispense, Mix, Purge, Prompt, Loop and Tip Spacing” presented in [“5.2 Detailed description of pipetting modes”](#) on page 35. The custom programming mode is described in [“5.3 Custom step-based programming mode”](#) on page 45

5.1 Overview pipetting modes

The table below provides an overview of the selectable pipetting modes. All modes are accessed from the Main Menu. Use the **Touch Wheel** to scroll to your desired pipetting mode.

Pipetting mode	Description
Pipet	Allows liquid transfers when aspirate and dispense volumes are equal.
Repeat Dispense	Allows dispensing multiple aliquots of the same volume without refilling the tips after each dispense for fast microplate filling and processing.
Sample Dilute	Allows aspirating of sample and diluent divided by a defined air gap into one tip, followed by a complete dispense.
Pipet/Mix	Transfers a defined volume and follows with a defined number of automatic mixing cycles.
Manual Pipet	Allows the operator to manually control the aspiration and dispensing up to the set volume.
Reverse Pipet	Allows liquid transfers of viscous or high vapor pressure liquids by preventing introduction of any air into the sample. The aspiration volume is higher than the volume to be dispensed.
Variable Dispense	Allows dispensing multiple aliquots of different volumes.
Multi Aspirate	Allows aspirating multiple aliquots of different volumes.
Sample Dilute/Mix	Allows aspirating two liquids separated by an air gap followed by a complete dispense and Mix step.
Serial Dilution	Allows aspirating a transfer volume followed by a mix. Rows and Mix Cycles are tracked on the display.
Custom Programs	Allows to create and store of up to 40 multi-stepped pipetting protocols.

Press the **OK** to access the pipetting mode and to start defining parameters.

5.2 Detailed description of pipetting modes

The VIAFLO/VOYAGER Electronic Pipettes offer ten predefined pipetting modes. Most liquid handling protocols can be easily accommodated using these modes. The options and steps of the different pipetting modes are described in the following subsections.

Every predefined program can be saved as a custom program. After setting up the pipetting mode with your parameters, select ►Custom. Enter a name for the program. The program is stored in the Custom program section.

5.2.1 Pipet mode

Application: Use this mode for quick transfers of liquid.

Options	Steps	Description
Edit	Aspirate	Sets the aspiration volume that is equal to the dispense volume.
Asp. Speed		Sets speed for aspirating (1 = slow, 10 = fast).
Disp. Speed		Sets speed for dispensing (1 = slow, 10 = fast).
Tip Spacing	First, (Middle), Last	Sets two or three tip spacing values based on labware types to be used (VOYAGER only).
Favorites		Defines up to 10 favorite volumes
Custom		Converts the predefined program into a custom program.

Operation:

- With the tip(s) in liquid, press and release the **RUN Key** to aspirate.
- With the tip(s) in the destination plate, press and hold the **RUN Key** to execute the dispense and perform a two-step blowout, see [“4.3.2 Blowout modes” on page 25](#).
- When the tips are removed from the target plate, release the **RUN Key**.

5.2.2 Repeat dispense mode

Application: This mode can be used for fast reagent addition to microplates from one source container. You can dispense a large aspirated volume of liquid in multiple aliquots to multiple targets.

Options	Steps	Description
Edit	Dispense	Sets the volume for repetitive dispensing. The aspirated volume is calculated automatically.
	Count	The maximum number of dispenses possible (count) is calculated automatically. This count may be reduced to the desired number.
	Pre-Dispense	A pre-dispense volume can be selected independently to improve accuracy and precision. The dispense is discarded.
	Post-Dispense	A post-dispense volume can be selected independently to improve accuracy and precision. The dispense is discarded.
	Reuse Post-Disp.	By default (red ✖), the mode ends with dispensing of the post-dispense. This aliquot contains the accumulated error from all prior dispenses. If you want to reuse the post-dispense, press OK (green ✓). At the end of the program the post-dispense remains in the tip, while the pipette is ready to aspirate a new volume to start the next repeat dispense run.
	Asp. Speed	Sets speed uniquely for aspirating (1 = slow, 10 = fast).
	Disp. Speed	Sets speed uniquely for dispensing (1 = slow, 10 = fast).
Speed		Sets speed of the current pipetting step.
Tip Spacing	First, (Middle), Last	Sets two or three tip spacing values based on labware types to be used (VOYAGER only).
Pace		Sets the time duration between dispenses, if keeping RUN Key pressed (1 = slow, 9 = fast).
Custom		Converts the predefined program into a custom program.

Operation:

- With the tip(s) in liquid, press and release the **RUN Key** to initiate the aspirate step.
- Press and release the **RUN Key** for every dispense. Alternatively, press and hold **RUN** to execute paced dispenses. The dispense number is shown on the display.
- The pipette will stop paced dispenses when it reaches the post-dispense. You can choose to use this post-dispense or discard it.
 - If reuse of post-dispense is not activated, press and hold the **RUN key** to purge the post-dispense volume with a two-step blowout.
 - If reuse of post-dispense is active, you can start the next repeat dispense cycle with aspirating liquid to the post-dispense in the tip. To finish the repeat dispense cycle, press **Purge**.

5.2.3 Sample dilute mode

Application: Accomplish accurate sample dilutions by using diluent to “chase” small sample volumes from the pipet tips. An air gap keeps liquid separated in the tips and helps to minimize carryover of diluent when aspirating the sample.

Options	Steps	Description
Edit	Aspirate 1	Sets the volume of the diluent aspirated first in the tip.
	Air Gap	Sets the volume of the air gap to keep both liquids separated.
	Aspirate 2	Sets the volume of the sample in the tip.
	Asp. Speed	Sets speed uniquely for aspirating (1 = slow, 10 = fast).
	Disp. Speed	Sets speed uniquely for dispensing (1 = slow, 10 = fast).
Speed		Sets speed of the current pipetting step.
Tip Spacing	First, (Middle), Last	Sets two or three tip spacing values based on labware types to be used (VOYAGER only).
Custom		Converts the predefined program into a custom program.

Operation:

- Press and release the **RUN Key** to initiate each aspiration (remove tips from liquid for air-gap aspiration).
- Press and hold the **RUN Key** to perform a two-step blowout. The entire tip contents will be dispensed together.

5.2.4 Pipet/Mix mode

Application: Use this mode when mixing is required immediately after transfer of liquid. This mode saves a programming step by incorporating the mix option after dispensing.

Options	Steps	Description
Edit	Aspirate	Sets the aspiration volume that is equal to the dispense volume.
	Mix	Sets the mixing volume after dispensing.
	Mix Cycles	Sets the number of mix cycles.
	Asp. Speed	Sets speed uniquely for aspirating (1 = slow, 10 = fast).
	Mix Speed	Sets speed uniquely for mixing (1 = slow, 10 = fast).
Speed		Sets speed of the current pipetting step.
Tip Spacing	First, (Middle), Last	Sets two or three tip spacing values based on labware types to be used (VOYAGER only).
Custom		Converts the predefined program into a custom program.

Operation:

- Press and release the **RUN Key** to initiate the aspiration.
- Press and release the **RUN Key** to dispense. Mixing occurs automatically after the dispense step.
- Upon completing the desired number of mixes, a blowout is initiated automatically prompting you to remove the tip(s) from the liquid and press **RUN** to complete the blowout.

5.2.5 Manual pipet mode

Application: This mode can be used when the aspiration volume is not defined or unknown. You have control over the aspiration and dispense steps and can view the display to confirm how much liquid has been aspirated or dispensed. Manual control over the dispense steps is perfect for performing titrations or for controlling the loading of samples in gel lanes.

Options	Steps	Description
Edit	Aspirate	Sets the aspiration or dispensing volume. Toggle between Aspirate and Dispense using the Direction menu option.
Speed		Sets speed of the current pipetting step (1 = slow, 10 = fast).
Tip Spacing	First, (Middle), Last	Sets two or three tip spacing values based on labware types to be used (VOYAGER only).
Direction		Changes the direction of pipetting between aspiration and dispensing.
Favorites		Defines up to 10 favorite volumes

Operation:

- When aspirating, the motor will stop when you release the **RUN Key** or when the programmed aspirate volume is reached.
- You can change pipetting direction at any time even if aspiration volume is not reached. Change the direction of pipetting by pressing **OK** on the Direction option. The notation on the display changes between Δ (Aspirate) and ∇ (Dispense).
- Titrations can be performed by dispensing in this mode. The volume remaining in the tip(s) is always actively displayed.



NOTE

Use slower pipetting speeds (1–5) for better control and resolution.

5.2.6 Reverse pipet mode

Application: With this mode the aspiration volume is higher than the volume dispensed. It is recommended for liquid transfers of viscous and high vapor pressure liquids. The dispense method prevents introduction of air into the sample because no blowout is made.

Options	Steps	Description
Edit	Dispense	Sets the dispense volume.
	Post-Dispense	Sets the volume to leave in the tip until final blowout.
	Reuse Post-Disp.	By default (red ✖), the mode ends with dispensing of the post-dispense. If you want to reuse the post-dispense, press OK (green ✔). At the end of the program the post-dispense remains in the tip, while the pipette is ready to aspirate a new volume to start the next reverse dispense run.
	Asp. Speed	Sets speed uniquely for aspirating (1 = slow, 10 = fast).
	Disp. Speed	Sets speed uniquely for dispensing (1 = slow, 10 = fast).
Speed		Sets speed of the current pipetting step.
Tip Spacing	First, (Middle), Last	Sets two or three tip spacing values based on labware types to be used (VOYAGER only).
Custom		Converts the predefined program into a custom program.

Operation:

- Press and release the **RUN Key** to initiate the aspiration. The total volume aspirated is the sum of desired dispense volume and post-dispense volume.
- Press and release the **RUN key** to dispense the programmed volume.
- If reuse of post-dispense is not activated, press and hold the **RUN key** to purge the post-dispense volume with a two-step blowout.
- If reuse of post-dispense is active, you can start the next reverse pipet cycle with aspirating liquid to the post-dispense in the tip. To finish the reverse pipet cycle, press **Purge**.

5.2.7 Variable dispense mode

Application: Use this mode when differing dispense volumes are required. This mode could be used to quickly set up a dilution series in plates or for feeding similar samples to different assay plates where different sample volumes are needed.

Options	Steps	Description
Edit	Count	Sets the total number of dispensing steps.
	Dispense 1...Count	Sets different volumes for every variable dispense step. The maximal Count depends on pipette size. The total volume is automatically calculated.
	Pre-Dispense	A pre-dispense volume can be selected independently to improve accuracy and precision. The dispense is discarded.
	Post-Dispense	A post-dispense volume can be selected independently to improve accuracy and precision. The dispense is discarded.
	Asp. Speed	Sets speed uniquely for aspirating (1 = slow, 10 = fast).
	Disp. Speed	Sets speed uniquely for dispensing (1 = slow, 10 = fast).
Speed		Sets speed of the current pipetting step.
Tip Spacing	First, (Middle), Last	Sets two or three tip spacing values based on labware types to be used (VOYAGER only).
Pace		Sets the time interval between dispenses in repeat pipetting (1 = long, 9 = short).
Custom		Converts the predefined program into a custom program.

Operation:

- Press and release the **RUN Key** to initiate the aspiration of total volume.
- Press and release the **RUN Key** to initiate each subsequent dispense. The pipette stops and beeps when ready for the Last Dispense step, i.e. to purge the calculated waste volume amount.
- Alternatively, press and hold the **RUN Key** to execute paced dispenses. The pipette stops paced dispensing when it reaches the Last Dispense. This aliquot contains the accumulated error from all prior dispenses. You can choose to use this Last Dispense or discard it.
- During the Last dispense, press and hold the **RUN Key** to perform a two-step blowout.

5.2.8 Multi Aspirate mode

Application: This mode can be used for a variety of collection applications where the aspiration volume is well known. This mode is also suited for supernatant collection in microplates.

Options	Steps	Description
Edit	Count	Sets the total number of aspirating steps.
	Aspirate 1...Count	Sets different volumes used for sequentially aspirating (in the same tip) followed by a single dispense. The maximal Count depends on pipette size.
	Asp. Speed	Sets speed uniquely for aspirating (1 = slow, 10 = fast).
	Disp. Speed	Sets speed uniquely for dispensing (1 = slow, 10 = fast).
Speed		Sets speed of the current pipetting step.
Tip Spacing	First, (Middle), Last	Sets two or three tip spacing values based on labware types to be used (VOYAGER only).
Custom		Converts the predefined program into a custom program.

Operation:

- With the tip(s) in liquid, press and release the **RUN Key** to initiate the first aspiration volume. Again in liquid, press and release the **RUN Key** to initiate the second aspiration volume, etc.
- Press and hold the **RUN Key** to start Dispense and perform a two-step blowout.

5.2.9 Sample Dilute/Mix mode

Application: Use this mode to perform sample dilutions where mixing of sample and diluent is required. This mode could also be used to introduce and mix diluent and sample to the first column of a serial dilution plate.

Options	Steps	Description
Edit	Aspirate 1	Sets the volume of the diluent aspirated first in the tip.
	Air Gap	Sets the volume of the air gap to keep both liquids separated.
	Aspirate 2	Sets the volume of the sample in the tip.
	Mix	Sets the mixing volume after dispensing.
	Mix Cycles	Sets the number of mix cycles.
	Asp. Speed	Sets speed uniquely for aspirating (1 = slow, 10 = fast).
	Mix Speed	Sets speed uniquely for mixing (1 = slow, 10 = fast).
Speed		Sets speed of the current pipetting step.
Tip Spacing	First, (Middle), Last	Sets two or three tip spacing values based on labware types to be used (VOYAGER only).
Custom		Converts the predefined program into a custom program.

Operation:

- With the tip(s) in liquid, press and release the **RUN Key** to initiate aspiration 1. With the tip(s) out of the liquid, press and release the **RUN Key** for the Air Gap. Again in liquid, press and release the **RUN Key** to initiate aspiration 2.
- Press and release the **RUN Key** to dispense the entire tip contents and begin the mixing routine. Upon completing the desired number of mixes, a blowout occurs automatically. Remove tips from liquid and press and release the **RUN Key** to complete the blowout.

5.2.10 Serial Dilution mode

Application: Use this mode to perform serial dilutions. The Serial Dilution mode enables aspiration of a specific volume followed by a mix sequence and ending with the original aspiration volume in the tips.

Options	Steps	Description
Edit	Aspirate	Sets the aspiration volume that is identical to the dispense volume.
	Mix	Sets the mixing volume after dispensing.
	Mix Cycles	Sets the number of mix cycles.
	Rows	Sets the number of rows. A row indicator will notify the number of dilutions performed.
	Asp. Speed	Sets speed uniquely for aspirating (1 = slow, 10 = fast).
	Mix Speed	Sets speed uniquely for mixing (1 = slow, 10 = fast).
	Disp. Speed	Sets speed uniquely for dispensing (1 = slow, 10 = fast).
Speed		Sets speed of the current pipetting step.
Tip Spacing	First, (Middle), Last	Sets two or three tip spacing values based on labware types to be used (VOYAGER only).
Custom		Converts the predefined program into a custom program.

Operation:

- With the tip(s) in liquid, press and release the **RUN Key** to initiate the aspiration of the reagent.
- Submerge the GripTips in the liquid located in the first row of the plate. Press and release the **RUN Key** to start the dispense and mix sequence. Proceed with the rest of the rows.
- Rows (first number) and Mix Cycles (second number) are tracked on the display. Mix Cycles are shown in red when mixing. A green dot on the row number indicates the active program step.

5.3 Custom step-based programming mode

Application: Use the Custom program mode to create personalized pipetting protocols. Up to forty programs can be stored.

5.3.1 Create a custom program

From the Main Menu select “Custom” to create a personalized protocol. Programs can contain up to 98 individual steps based upon the following basic operations: Aspirate, Dispense, Mix, Purge, Tip spacing, Prompt and Loop.



NOTE

We recommend creating custom programs on a PC with the VIALINK software, see also [“3.4.3 Communications” on page 21](#).

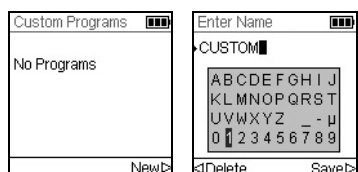

Press New \triangleright to create a new program. Your are prompted to enter a name.

Use the **Touch Wheel** to select characters and press **OK**. Once finished, press \triangleright to save the name.

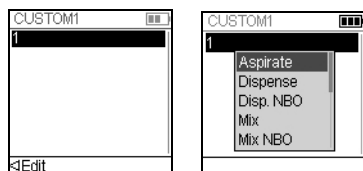

The first step is highlighted, press **OK**. A Custom program must begin with an Aspirate, Mix, Prompt or Tip spacing. Use the **Touch Wheel** to select the first step, e.g. Aspirate, and press **OK**.

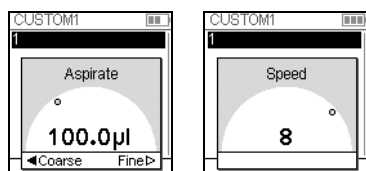

Set the volume value and press **OK**.

Set the speed for that step and press **OK**.

After adding the first step, the selection should now be on the second line. Press **OK** again to define the second step. Continue adding steps until your entire pipetting protocol is defined.



IMPORTANT NOTE

When starting with an “Aspirate” step followed by a “Mix” step, the tips contain the aspirate volume after completing the last mix cycle. When starting with a “Mix” step, the tips are emptied upon completion of the last mixing cycle.

To add a Tip Spacing step for VOYAGER pipettes, press **OK**, scroll down to Tip Spacing and press **OK**.

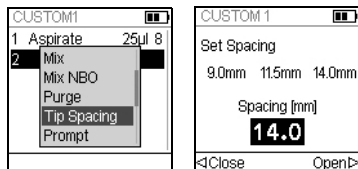

Select one of the given tip spacings using the **Touch Wheel** and press **OK**. Alternatively press **<** and **>** to define a new tip spacing.

The individual steps based upon the following basic operations:

Step	Description
Aspirate	Sets the aspiration volume and speed.
Dispense	Sets the dispense volume and speed.
Disp. NBO (No BlowOut)	Sets the volume and speed for a dispense without blowout. Residual liquid may remain in the tip, resulting in inaccurate and imprecise liquid delivery. Select this step only if accuracy and precision are not important.
Mix	Sets the mixing volume and speed.
Mix NBO (No BlowOut)	Sets the mixing volume and speed without a blowout after the last dispense. Residual liquid may remain in the tip, resulting in incomplete mixing and inaccurate and imprecise liquid delivery. Select this step only if introduction of air into the sample must be prevented.
Purge	Purges all remaining liquid currently in the GripTips. A “Purge” step is automatically integrated at the end of a program if the last programming step leaves liquid in the tips.
Tip Spacing	Sets the desired Tip Spacing (VOYAGER pipettes only).
Prompt	The prompt displays a user defined message during the program. Use the Touch Wheel to select one of 3 lines and press OK . Highlight a character that you want to use and press OK . Enter up to 12 characters per line. After you enter the desired text, press > to Save.
BlowOut	Performs a blowout. A blowout needs to be performed after the last dispense to expel residual liquid. Note: When using a standard “Dispense” step or “Purge”, a blowout/blowin is performed automatically to empty the tips and does not need to be programmed.

BlowIn	If a BlowOut step was added, it needs to be followed directly with a BlowIn. It brings the piston(s) back to the home position. Make sure to remove the tips from the liquid before starting the BlowIn.
Timer	Sets a timer from 0 s to 60 min. When the count down is finished, the next step is performed automatically. If under Preferences - Sounds the option Messages is set to On a beep tone sounds.
Loop	A loop repeats the steps between the selected step and the loop command. E.g. if the program reaches the loop step, it goes back to step 2 and repeats the steps until there 4 times.
Beep	Sets a beep. The sound is only active, if under Preferences - Sounds the option Messages is set to On.

To save and store a Custom program, press Save ▷. To run the program, press **OK**.

5.3.2 Modify existing programs

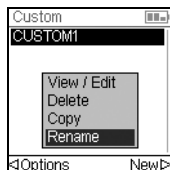

At the Custom program display, use the **Touch Wheel** to highlight an existing program and press ◀ Options. Select an option (View/Edit, Delete, Copy, Rename) to modify the program.

With the View/Edit option you can always add a new step, edit a step, or delete a step.

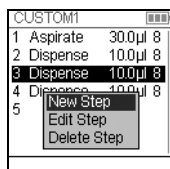

To insert a new step, press ◀ Edit, select New Step and press **OK**.

Use the **Touch Wheel** to select the position where a new step should be inserted and press **OK**. Select an operation and press **OK**.

Press Save ▷ to return to the list of Custom programs.

5.3.3 Example of custom mode

Application: The task is to combine 2 different liquids in a 96 well plate for a kinetic assay and then mixing it to achieve a homogeneous solution. The custom program would be set up as followed:

Program step	Action
1. Aspirate liquid 1: 160 µl (e.g. diluent)	With tips in liquid 1 press RUN Key .
2. Aspirate air: 20 µl	Move tips out of liquid and press RUN Key .
3. Aspirate liquid 2: 50 µl (e.g. reagent)	With the tips in liquid 2 press RUN Key .
4. Dispense: 230 µl	Press and hold RUN Key until liquid is dispensed and tips are removed from the liquid (two-step blowout).
5. Mix 3x: 200 µl	Press RUN Key .

Purge does not need to be programmed. The residual liquid is dispensed into the waste container. Press and hold **RUN Key** until liquid is purged and tips are removed from the liquid (two-step blowout). For a detailed description see [“4.3.2 Blowout modes” on page 25](#).

6 Maintenance



WARNING

Always turn off power and disconnect the VIAFLO/VOYAGER Electronic Pipettes from the mains when carrying out maintenance work.

6.1 Cleaning

The materials used on the exterior of the electronic pipettes support regular cleaning intervals. Clean the external components with a lint-free cloth lightly soaked with mild soap solution in distilled water or with a 70 % dilution of Isopropyl or Ethanol. Never use Acetone or other solvents.



WARNING

Do not immerse the entire pipette into a cleaning solution or spray cleaning solution directly onto the exterior body of the pipette as this can potentially damage internal electronics.

If liquid ever enters the internals of the pipettes, please contact your service technician.

6.2 Assembly and Disassembly

6.2.1 VIAFLO single channel lower end

Disassembly

Disassemble the lower part of the single channel pipette as follows:



Models of all sizes:

- 1) Ensure the pipette is in the “home” or down position (at the end of a pipetting cycle).
- 2) Turn off power and unplug the mains adapter.
- 3) Unscrew counterclockwise to remove the **Cylinder Assembly** (a) from the pipette. Slide the Cylinder Assembly down from the pipette body. This exposes the **Piston Assembly** (b, models 12.5 μ l–300 μ l) or **Piston** (model 1250 μ l).

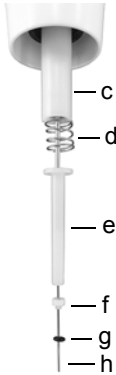

Model 12.5 µl:

- 4) Slide the following components from the Piston (h):
- **O-Ring (black, g) and Seal (white, f) Assembly**
 - **Lower Seal Retainer (white, e)**
 - **Seal Retainer Spring (d)**
 - **Seal Retainer (white, c)**
- Set these components aside or place them in an autoclave pouch.

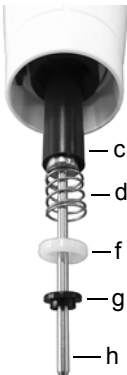

Model 50 µl:

- 4) Slide the following components from the Piston (h):
- **Flange (black, g) and Seal (white, f) Assembly**
 - **Seal Retainer Spring (d)**
 - **Seal Retainer (black, c)**
- Set these components aside or place them in an autoclave pouch.

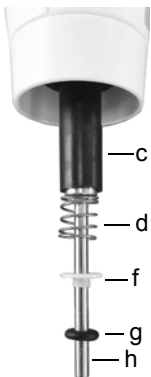

125 µl

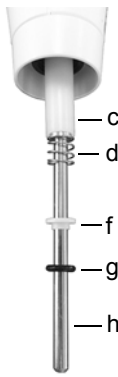

300 µl

Models 125 µl and 300 µl:

- 4) Slide the following components from the Piston (h):
- **O-Ring (black, g) and Seal (white, f) Assembly**
 - **Seal Retainer Spring (d)**
 - **Seal Retainer (black or white, c)**
- Set these components aside or place them in an autoclave pouch.

**Models 12.5 µl–1250 µl:**

- 5) Separate the **Piston** (h) from the upper part of the pipette. The Piston is held in place by a small magnet.
- 6) With the **Cylinder Assembly** (a) in hand, turn counterclockwise to remove the black **Snap Ring** (i) that holds the black **Cylinder** (k) in place.
- 7) Pullout the black **Cylinder** (k) from the white **Ejector Sleeve** (l).
- 8) Remove the **Ejector Spring** (j).

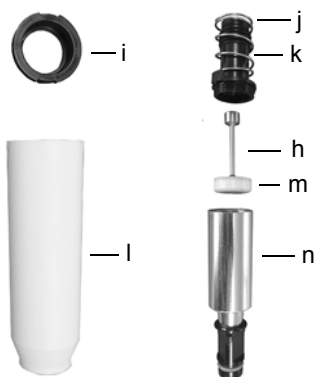
**Model 5000 µl:**

- 4) With the **Cylinder Assembly** (a) in hand, turn counterclockwise to remove the black **Snap Ring** (i) and pull out the **Cylinder** (k).
- 5) Remove the **Ejector Spring** (j).
- 6) With the upper black part (k) of the **Cylinder** in hand unscrew counterclockwise the metallic cylinder (n).
- 7) Remove the **Piston** (h). The **Cup Seal** (m) is mounted directly on the piston.

- 9) Set all components of the lower part aside or place them in an autoclave pouch.

Reassembly

Before reassembling the pipette, check each component for lint or dust particles. It is recommended to replace the **O-Ring** (black, g) and **Seal** (white, f) or **Cup Seal** (m), see “9.2 Consumables” on page 72.

- 1) Lightly lubricate the Piston, O-Rings and Seals (see “6.4.3 Lubrication” on page 56).

Models 12.5 µl–1250 µl:

- 2) Position the **Piston** (h) at the small magnet to connect the Piston to the upper part of the pipette.

Models 12.5 µl–300 µl:

- 3) Slide the **Seal Retainer** (c) onto the Piston and up into the pipette. The end of the Seal Retainer that has an extended edge (lip) faces the upper part of the pipette.
- 4) Slide the **Seal Retainer Spring** (d) onto the Piston. It rests against the Seal Retainer. Slide the **Lower Seal Retainer** (e, 12.5 µl only) onto the Piston.
- 5) Slide the lightly lubricated **O-Ring** (black, g) and **Seal** (white, f) **Assembly** onto the Piston. The white Seal is closest to the Seal Retainer Spring. Be sure the black O-Ring is securely slid into the white Seal.

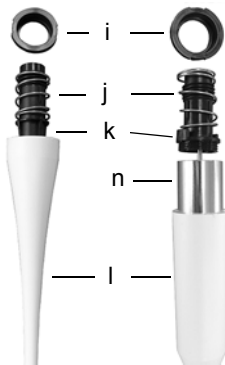
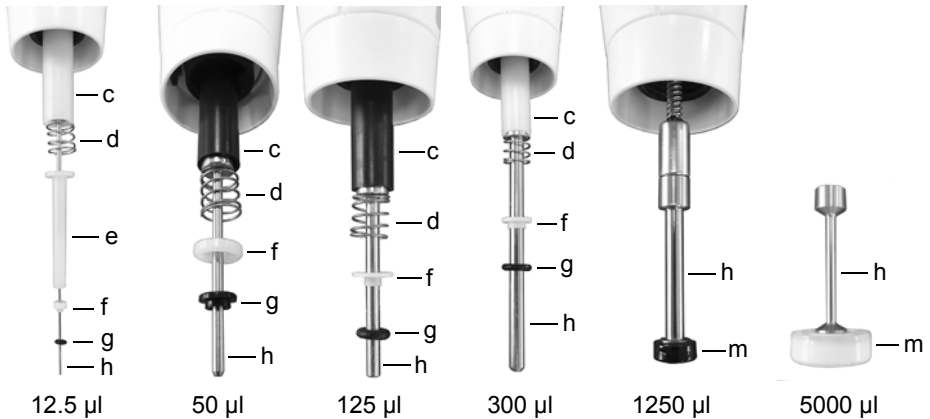

Model 5000 µl:

- 2) Push the **Cup Seal** (m) of the piston into the top of the metallic cylinder (n) and screw the metallic cylinder on the upper plastic part (k) of **Cylinder**.

Models of all sizes:

- 6) Slide the **Ejector Spring** (j) onto the top of the black **Cylinder** (k).
- 7) Slide the **Cylinder** (k) into the white **Ejector Sleeve** (l).
- 8) Position the black **Snap Ring** (i) over the **Cylinder** (k) at the top of the **Ejector Sleeve** (l). Turn the sleeve clockwise until the Snap Ring snaps into place and secures the Cylinder in the Cylinder Assembly.

12.5–1250 µl 5000 µl

- 9) Slide the **Cylinder Assembly** (a) over the **Piston** (h, models 12.5 µl–1250 µl). Screw clockwise to attach the Cylinder Assembly to the body of the pipette.

Perform a leak test (see [“7.3.5 Leak test”](#) on page 59) and validate pipetting volumes after reassembly.

6.2.2 VIAFLO multichannel pipettes

Disconnect the lower part from the upper part of the multichannel pipette before sterilization. Refer to chapter [6.3](#) for sterilization instructions. Do not open the housing of the lower part.

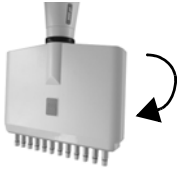

Step 1

Disassembly:

Rotate counter-clockwise for approximately 5 revolutions to remove the lower assembly.

Reassembly:

Rotate clockwise until you feel a stop; then back off to align both volume labels.



Step 2

Disassembly:

Gently pull to separate the upper and lower assembly to expose the ball and socket.

Reassembly:

Gently push together the upper and lower assembly.

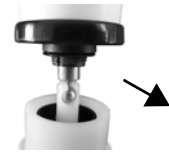

Step 3

Disassembly:

Disengage the ball and socket to separate the parts.

Reassembly:

Reengage the ball and socket to reconnect.



Step 4

Disassembly:

Remove black cover-ring from upper assembly.

Reassembly:

Place cover-ring on upper assembly.



CAUTION

VIAFLO pipettes can only be completely disassembled by trained service personnel.

6.3 Sterilization

If the surface of the VIAFLO/VOYAGER Electronic Pipettes have been in contact with biohazardous material, it must be decontaminated in accordance to good laboratory practice. Wipe the clean surface with a lint-free cloth, lightly soaked e. g. with the following disinfectants:

- Ethanol 70 %
- Microcide SQ 1:64
- Glutaraldehyde solution 4 %
- Virkon solution 1-3 %

Follow the instructions provided with the disinfectants.

It is not recommended to autoclave the VIAFLO pipettes. If autoclaving is required, only the lower assembly of the VIAFLO single channel pipettes or the entire lower part of the VIAFLO multi-channel pipettes can be autoclaved. The design of the pipettes ensures that liquids and aerosols cannot reach the upper inner electronic part of the pipettes.



WARNING

Service is required after autoclaving the VIAFLO pipettes!

Do not autoclave the entire unit. The extreme heat can damage the display and other electrical components.

VIAFLO pipettes can NOT be autoclaved!

As-found calibration (measurement report, indicating “before” data) is not possible after autoclaving!

6.3.1 Autoclaving the disassembled components

Place the disassembled components (see [6.2](#)) into steam inside an autoclave pouch in the autoclave:

Single channel 12.5–1250 µl:



Single channel 5000 µl:



You may autoclave the components at 121°C, 1 bar overpressure for 20 minutes.

6.4 Servicing

6.4.1 Shipping to INTEGRA Biosciences

For any service or repairs, please contact your local service technician.

**WARNING**

If working with infectious materials, e. g. human pathogens, VIAFLO/ VIAFLO pipettes need to be decontaminated before sending them to service and the declaration on the absence of health hazards must be signed. This is necessary to protect service personnel.

6.4.2 Changing O-rings of tip fittings

300 μ l, 1250 μ l and 5000 μ l pipettes feature tip fittings with red O-rings. This O-ring is used to seal against the inside wall of GripTips and provides a robust seal.

O-rings are made of durable silicone. If necessary, e.g. in case of a leakage due to damaged O-ring, you can replace these O-rings. A set of spare O-rings and an O-ring removal tool are included with the 300 μ l and 1250 μ l pipettes and can be ordered separately, see “9 Accessories” on page 71.

**WARNING**

Avoid mechanical damage of the tip fittings.



For 300 μ l or 1250 μ l pipettes choose the side of the O-ring removal tool corresponding to the size of the pipette cylinder (300 μ l or 1250 μ l). Slide the O-Ring removal tool sideways onto the tip fitting until the O-ring (a) builds a loop. Remove the O-ring with fine plastic tweezers.

For 5000 μ l pipettes, simply use plastic tweezers to remove the O-ring.



Slide a new O-ring over the tip fitting (b).

6.4.3 Lubrication

The internal seals and O-rings are subject to wear. An undamaged thin lubricant film is important to keep the seals tight. The lubricant recommended depends on the VIAFLO pipette size, see “9.2 Consumables” on page 72:

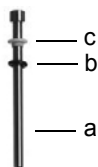

Single channel 12.5–300 µl models:

Use Fluorocarbon Gel (#100-00136-50) to lightly lubricate the piston (a) without components (c, d) slid onto. Put a drop of grease onto your fingers, lubricate the black O-ring (b) and slide it over the white seal (c).

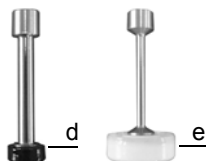

Single channel 1250 µl and 5000 µl models:

Use the Super-O-Lube (#100-00135-50) to lightly lubricate the outer ring of the Cup Seals (d, e). Do not lubricate the bottom of Cup Seals.

6.5 Equipment disposal



The VIAFLO/VOYAGER Electronic Pipettes must not be disposed of with unsorted municipal waste. Do not dispose of the pipettes in a fire.



VIAFLO/VOYAGER Electronic Pipettes contains a Li-ion battery. Do not modify the battery in any way. Dispose of the pipettes and the batteries separately in accordance with the laws and regulations in your area governing disposal of devices containing Li-ion batteries.

7 Calibration

This chapter provides a guideline to calibrate VIAFLO/VOYAGER Electronic Pipettes. For commercial calibration laboratories, different regulations and requirements may apply. For information regarding calibration service, please contact your local dealer.

7.1 Definitions

Blow-out: Discharges any residual liquid from the pipette tip by expelling extra air.

Blow-in: After the blow-out, the piston moves back into home position. This causes a slight intake of air (or liquid if tips remain in the liquid). To avoid an early blow-in, keep the **RUN Key** pressed while dispensing, remove the tips from liquid and then release the **RUN Key**.

Pre-wet: The action of pre-coating the inside of the liquid contacting parts with a thin film of the same liquid. Additionally, it equilibrates humidity of the air space inside tip and the pipette.

Touch off: Touching the pipette tip against the liquid surface or the sidewall of a well-plate to release any residual liquid that might cling to the pipette tip end.

Calibration: The process of establishing the relationship between a target volume and the corresponding actual dispensed volume. (Interpretation of “calibration” according to VIM 3rd edition, 2008.)

Adjustment: Adjustment of the piston stroke length to agree with the value of the specified target volume.

Accuracy: The ability of a pipette to aspirate or dispense the desired, exact volume. It describes the closeness of a measurement to the true value. Accuracy is also known as systematic error or trueness. It can be adjusted.

Precision: Precision describes the repeatability or reproducibility of the measurement. It is also called random error and is therefore an unpredictable error, which cannot be adjusted.

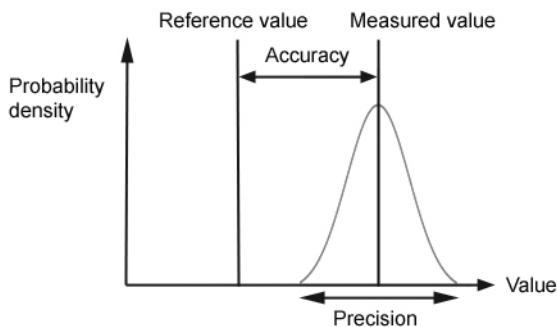

Illustration of accuracy and precision.

7.2 Materials

- Precision balance with 0.01 mg readability
- ASTM Class 2 or OIML E2 test weights, e. g.:
 - 1 mg OIML E2, Mettler-Toledo part no. 158307
 - 1 g OIML E2, Mettler-Toledo part no. 158397
- Evaporation trap for balance
- Weighing vessel (optimally the height-to-diameter ratio is at least 3:1)
- Measurement equipment for temperature, humidity and atmospheric pressure (e.g. Testo 435-2 Professional).
If no barometer is available, search the internet for atmospheric pressure at a local weather station.
- Distilled water (optimal: conforming grade 3 according to ISO 3696)
- New non-filtered GripTips matching the pipette volume (see section [9.2](#))
- Charging option for pipette, e.g. single pipette charging stand (part no. 4210)
- Beaker or reagent reservoir 100 ml (part no. 4322) with distilled water for pre-wetting and calibration
- Ethanol or Isopropyl 70 %.

7.3 Preparation

7.3.1 Test conditions and environment

Tests and calibrations should be performed in conditions and environment according to ISO 8655-6 standard.

- Temperature needs to be between 18–25 °C and remain constant (± 0.5 °C) throughout the calibration.
- Optimal relative humidity of the environment is >50% and around the dispensing position 80%.
- GripTips, pipettes and distilled water need to be in the calibration laboratory for at least 2 hours prior to calibration to reach temperature equilibrium with the environment.
- Balance needs to be situated in a draft free environment.
- The balance must be validated using reference weights before and after a measuring series. Reference weights approximately corresponding to low and high test volume should be used. See section [7.2](#).

7.3.2 Cleaning

- Check the pipette for visual signs of damage.
- Clean the exterior housing of the pipette and the tip fittings, see [6.1](#).

7.3.3 Firmware

- Check firmware version and perform an update if necessary. Please refer to the separate update instructions (Operating Instructions VIALINK) when performing an update.

7.3.4 Pre-wetting of tips

Pre-wet new GripTips three times prior to starting tests and calibrations. This is required every time a tip is changed.

- 1) Attach a new unused GripTip which correspond to the volume range of the pipette directly from the rack without touching the tip by hand.
- 2) In the Pipet mode, program the pipette to aspirate full volume. Set aspirating speed at 6.
- 3) Aspirate by pressing the **RUN Key**.
- 4) Dispense: Keep the **RUN Key** pressed until all liquid is expelled, remove the tip from the liquid and then release the **RUN Key** to perform a two-step blowout, see [“4.3.2 Blowout modes” on page 25](#).
- 5) Repeat steps 3 to 4 three times.

7.3.5 Leak test

To ensure the calibration is carried out with a mechanically sound pipette, a leak test should be performed. It is also recommended to perform this test regularly every 3 months, or when errors occur.

- 1) Pre-wet GripTips as described in section [7.3.4](#).
- 2) Choose the Pipet/Mix mode and set the following parameters:
 - Aspirate: maximum Volume
 - Mix: maximum Volume
 - Mix Cycles: 10
 - Aspiration speed: 6
 - Mixing speed: 6
- 3) Press **RUN** to aspirate.
- 4) Keep the pipette tips immersed 2 mm in the liquid and observe liquid levels for 30 seconds. Verify liquid levels are not decreasing during this time.
A decreasing level indicates a leak. Take note of affected channel(s).
- 5) With pipette tips still immersed approx. 2-3 mm in liquid, press the **RUN Key** to start the mix cycle.
 - a) Observe whether air bubbles are forming on the tip ends when dispensing.
 - b) On a multichannel pipette, also pay attention whether liquid levels move approximately on the same level across all channels.
 - c) At the end of a last dispense it is normal to have air bubbles because a blow-out is performed.
- 6) For a VIAFLO pipette, carry out steps 3-5 for closed and open tip positions (min. and max. tip spacing).

Signs indicating a leak

- 1) The liquid levels are not equal on all channels after aspiration.
- 2) Decreasing liquid level during 30 s wait time while tips are immersed in liquid.
- 3) Decreasing liquid level during mixing.
- 4) One or more channels show air bubbles during the mix cycle.

Leak remedy

- 1) Change O-rings (see [6.4.2](#)) and lubricate pistons (see [6.4.3](#)) of affected channels.
- 2) Contact INTEGRA customer support (customersupport@integra-biosciences.com).

7.4 Obtaining the Actual Volume

Perform at least 4 measurements each at 100 %, 50 % and at 10 % of the nominal volume. Start measurements with 100 % of nominal volume.

General

- 1) Always use new, unused GripTips, which correspond to the volume range of the pipette, also when changing the test volume, e.g. from 100 % to 50 %.
- 2) Always pre-wet (section [7.3.4](#)) when using a new GripTip.
- 3) Always pipet along the vessel wall or directly into the liquid (max. immersion depth 1–2 mm).

Gravimetric testing

- 1) Write down the ambient temperature and air pressure.
- 2) Perform a pre-wet, see [7.3.4](#).
- 3) Select the “Pipet” program and set test volume. Set speeds at 6.
- 4) The first dispense to the balance should not be recorded. It accustoms the balance to the test volume. After each dispense re-tare the balance.
- 5) Start the first measurement by dispensing the test volume and record the weight. During dispense, keep the **RUN Key** pressed. After dispensing draw the pipette tip end along the wall of the weighing vessel to perform a touch off, see section [7.1](#). Then release the **RUN Key**.
- 6) After completing the high volume measurements, continue with the mid and low test measurements by repeating steps 2–5.

7.5 Calculation of accuracy and precision

The following variables are used in the calculations:

V_s = Selected test or target Volume

m_i = Measured Liquid Weight (g or mg)

Z = Z factor, see [8.6](#)

V_i = Converted Volume (ml or μ l)

\bar{V} = Actual mean Volume (ml or μ l)

n = Number of measurements

Conversion of the mass to volume

The values obtained in [7.4](#) are balance readings in grams or milligrams. These values need to be converted to volumes using the Z correction factor. It takes into account the water density and air buoyancy during weighing at the corresponding test temperature. To determine the correct Z factor, find the intersection between temperature and air pressure in [Table 8.6](#). Round up temperature and air pressure values.

Convert each mass m_i to volume by multiplying it with the corresponding Z factor:

$$V_i = m_i \times Z$$

Add together the volumes V_i and divide the sum by n (number of measurements, e.g. $n = 5$) to calculate the mean volume \bar{V} .

$$\bar{V} = \frac{1}{n} \times \sum_{i=1}^n V_i$$

Calculation of systematic error (Accuracy)

The systematic error e_s can be calculated using the following equation with V_s being the selected test volume:

$$e_s = \bar{V} - V_s$$

or in percent:

$$e_s = \frac{100 \times (\bar{V} - V_s)}{V_s}$$

Calculation of random error (Precision %)

To calculate the random error as the repeatability standard deviation s_r , use the following equation:

$$s_r = \sqrt{\frac{\sum_{i=1}^n (V_i - \bar{V})^2}{n - 1}}$$

The random error can also be expressed as a percentage, by the coefficient of variation CV , using equation:

$$CV = 100 \times \frac{s_r}{\bar{V}}$$

7.6 Adjusting electronic pipettes

Compare the calculated accuracy and precision values with the corresponding pipette specifications given in section [8.5](#).

If a pipette has not met the calibration specifications it needs to be adjusted. This can easily be corrected by the pipette's software.

There are two modes for calibration of VIAFLO / VIAFLO Pipettes, "Pipette" calibration mode for neat transfers and "Repeat" calibration mode for pipetting aliquots.

The industry standard is to test and present specifications using neat transfers. This means aspirating and dispensing the same volume. The "Pipette" factor of the pipette's software determines the performance of neat transfers and is therefore adjusted in case a pipette performs out of specifications. Adjusting a pipette in "Repeat" calibration mode is normally not required and is not described in this document.

The following example is for a 300 µl pipette.

Select Toolbox on the Main Menu. Select the Calibration & Service and then the Calibration option. Press **OK**.

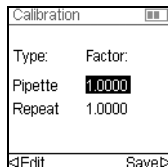

Highlight the Pipette Factor.

Press **OK** or < Edit to calibrate for Pipette mode.

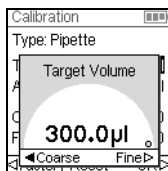

Highlight Target Volume (V_T) on the Calibration menu. Press **OK**.

Use the touch wheel to enter the Target Volume. Always use the nominal volume (100%) as target volume to adjust the pipette (300 µl in this example). Press **OK** to save your selection.

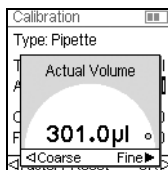

Move the cursor to the Actual Volume (\bar{V}). Use the touch wheel to enter the Actual Volume. Always use the high test volume (100% of nominal volume). The actual volume is the mean of the weights corrected by the Z factor, resulting in \bar{V} , the mean volume in micro liters (see section 7.5, 301 µl in this example). Press **OK** to save your selection.

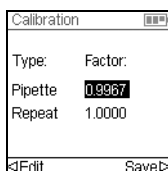

Press **>** to apply the correction factor. This will adjust the pipette to deliver the accurate volume. You are returned to the Calibration menu. Press **>** to Save your settings.

To display the Current and Factory Factors highlight the Pipette Factor on the Calibration menu and press **OK**. A message will indicate that the pipette recalibration is complete. To check and revalidate, repeat Steps 1–6 in Section 7.4.

In case a calibration reminder was set, it can be reset in the Calibration Reminder menu for either time and/or cycles.



NOTE

In case an error message appears when setting the new correction factor, follow these steps:

- a) *Select the Repeat factor in the calibration menu and enter the target and actual (measured) volume.*
- b) *Press >.*
- c) *Then select Pipet factor and enter target and actual volume.*
- d) *Press >.*
- e) *Both factors should be the same now.*
- f) *Press Save.*

8 Technical Data

8.1 Environmental conditions

	Operation
Temperature range	5–40 °C
Humidity range	Max. rel. humidity 80% for temperatures up to 31 °C, decreasing linearly to 50% rel. humidity at 40 °C.
Altitude range	< 2000 m

8.2 Specification of the device

Battery	Type: rechargeable, Li-ion, 3.7 V, 1050 mAh Typical charging time: 2.5 hours Charging cycles: 500–1000 (when charging as indicated) Running time: approx. 3000 pipetting cycles for single channel and 1500 for multichannel pipettes.
Electricity supply	Mains adapter input: 100–240 V, 50/60 Hz Device input: 5.7–6.4 V, 3 W
Pipetting channels	single, 4, 6, 8, 12 or 16
Pipetting speed	10 steps, adjustable in µl/s
Pipetting technology	Air displacement
User interface	Touch Wheel, color display

8.3 Pipetting speed

	Pipette Size					
	Default pipetting speed (micro litres per second)					
Speed	12.5 µl	50 µl	125 µl	300 µl	1250 µl	5000 µl
Min	0.1	0.4	0.7	1.6	6	24
1	0.5	2.6	4.9	11.6	47	179
2	1.0	5.2	9.8	23.3	93	358
3	2.6	13.0	24.3	57.8	232	890
4	3.1	15.7	29.4	70.1	281	1078
5	3.8	19.2	35.8	85.5	343	1315
6	5.2	25.9	48.5	115.7	464	1780
7	7.3	36.7	68.7	163.8	657	2520
8	9.7	48.9	91.5	218.2	875	3356
9	10.9	55.1	102.9	245.5	985	3777
10	12.5	63.0	117.7	280.8	1126	4319
Max	14.0	70.5	131.8	314.4	1261	4836

	Pipette Size					
	User defined pipetting speed (micro litres per second)					
Speed	12.5 µl	50 µl	125 µl	300 µl	1250 µl	5000 µl
Min. [µl/s]	0.07	0.4	0.7	1.6	6	24
Max. [µl/s]	14.01	70.5	131.8	314.4	1261	4836

8.4 Intellectual Property

The VIAFLO/VOYAGER Electronic Pipettes are covered under the following patents:

Patent Number	Country	Title	Apply to
7,662,343	USA	Locking Pipette Tip And Mounting Shaft	All pipettes
7,662,344	USA	Locking Pipette Tip And Mounting Shaft	GripTip/Tip fitting
5261392	JAPA	Locking Pipette Tip And Mounting Shaft	GripTip/Tip fitting
8,033,188	USA	Pipettor Software Interface	All pipettes
2192985	EPC/ FRAN/ GBRI/ SWIT	Pipettor Software Interface	All pipettes
602008010945	GERM	Pipettor Software Interface	All pipettes
D596,754	USA	Pipette	All pipettes
7,540,205	USA	Electronic Pipette Assembly	All pipettes
8,122,779	USA	Electronic Pipettor With Improved Accuracy	All pipettes
D596,755	USA	Multi-Channel Voyager	VOYAGER
8,029,742	USA	Multi-Channel Pipettor With Repositionable Tips	VOYAGER
8,128,892	USA	Programmable Multi-Channel Pipettor with Repositionable Tips	VOYAGER
D599,030	USA	Multi-Channel Pipette	Multichannel pipettes
7,811,522	USA	Sample Reservoir Kits With Disposable Liners	Reservoirs
D599,031	USA	A Liquid Sample Or Liquid Reagent Reservoir Kit	Reservoirs
8,277,757	USA	Pipette Tip Mounting Shaft	GripTips
8,501,118	USA	Disposable Pipette Tip	GripTips

8.5 Pipette Specifications

The specifications apply to neat transfers in Pipet mode only and represent the performance of all channels on a multichannel pipette.

Precision = coefficient of variation

VIAFLO Electronic Pipettes					Manufacturer	
Channel	Part No.	Volume Range (µl)	Volume Increments (µl)	Test Volume (µl)	Accuracy (±%)	Precision (≤%)
1	4011	0.5–12.5	0.01	1.25	5.00	4.00
				6.25	1.50	0.80
				12.5	1.00	0.40
1	4016	2–50	0.05	5.0	3.00	1.50
				25.0	1.50	0.60
				50	1.00	0.40
1	4012	5–125	0.1	12.5	3.00	1.00
				62.5	1.20	0.40
				125	0.60	0.20
1	4013	10–300	0.5	30	2.00	0.60
				150	1.00	0.30
				300	0.60	0.15
1	4014	50–1250	1	125	3.00	0.60
				625	1.00	0.30
				1250	0.60	0.17
1	4015	100–5000	5	500	3.00	0.75
				2500	1.20	0.30
				5000	0.60	0.15
8	4621	0.5–12.5	0.01	1.25	10.00	6.00
				6.25	4.00	1.60
				12.5	2.00	0.80
8	4626	2–50	0.05	5.0	5.00	2.50
				25.0	2.50	0.60
				50	1.50	0.40
8	4622	5–125	0.1	12.5	3.75	1.50
				62.5	2.50	0.70
				125	1.60	0.35

VIAFLO Electronic Pipettes					Manufacturer	
Channel	Part No.	Volume Range (µl)	Volume Increments (µl)	Test Volume (µl)	Accuracy (±%)	Precision (≤%)
8	4623	10–300	0.5	30	4.00	1.20
				150	2.00	0.60
				300	1.60	0.35
8	4624	50–1250	1	125	6.00	1.10
				625	2.40	0.50
				1250	1.20	0.30
12	4631	0.5–12.5	0.01	1.25	10.00	6.00
				6.25	4.00	1.60
				12.5	2.00	0.80
12	4636	2–50	0.05	5.0	5.00	2.50
				25.0	2.50	0.60
				50	1.50	0.40
12	4632	5–125	0.1	12.5	3.75	1.50
				62.5	2.50	0.70
				125	1.60	0.35
12	4633	10–300	0.5	30	4.00	1.20
				150	2.00	0.60
				300	1.60	0.35
12	4634	50–1250	1	125	6.00	1.10
				625	2.40	0.50
				1250	1.20	0.30
16	4641	0.5–12.5	0.01	1.25	10.00	6.00
				6.25	4.00	1.60
				12.5	2.00	0.80
16	4646	2–50	0.05	5.0	5.00	2.50
				25.0	2.50	0.60
				50	1.50	0.40
16	4642	5–125	0.1	12.5	3.75	1.50
				62.5	2.50	0.70
				125	1.60	0.35

VOYAGER Tip Spacing Pipettes					Manufacturer		
Channel	Part No.	Volume Range (µl)	Volume Increments (µl)	Test Volume (µl)	Accuracy (±%)	Precision (≤%)	Tip Spacing (mm)
4	4743	10–300	0.5	30	4.00	1.20	9.0–33.0
				150	2.00	0.60	
				300	1.60	0.35	
4	4744	50–1250	1	125	6.00	1.10	9.0–33.0
				625	2.40	0.50	
				1250	1.20	0.30	
6	4763	10–300	0.5	30	4.00	1.20	9.0–19.8
				150	2.00	0.60	
				300	1.60	0.35	
6	4764	50–1250	1	125	6.00	1.10	9.0–19.8
				625	2.40	0.50	
				1250	1.20	0.30	
8	4721	0.5–12.5	0.01	1.25	10.00	6.00	4.5–14.1
				6.25	4.00	1.60	
				12.5	2.00	0.80	
8	4726	2–50	0.05	5.0	5.00	2.50	4.5–14.1
				25.0	2.50	0.60	
				50	1.50	0.40	
8	4722	5–125	0.1	12.5	3.75	1.50	4.5–14.1
				62.5	2.50	0.70	
				125	1.60	0.35	
8	4723	10–300	0.5	30	4.00	1.20	9.0–14.1
				150	2.00	0.60	
				300	1.60	0.35	
8	4724	50–1250	1	125	6.00	1.10	9.0–14.1
				625	2.40	0.50	
				1250	1.20	0.30	

VOYAGER Tip Spacing Pipettes					Manufacturer		
Channel	Part No.	Volume Range (µl)	Volume Increments (µl)	Test Volume (µl)	Accuracy (±%)	Precision (≤%)	Tip Spacing (mm)
12	4731	0.5–12.5	0.01	1.25	10.00	6.00	4.5–9.0
				6.25	4.00	1.60	
				12.5	2.00	0.80	
12	4736	2–50	0.05	5.0	5.00	2.50	4.5–9.0
				25.0	2.50	0.60	
				50	1.50	0.40	
12	4732	5–125	0.1	12.5	3.75	1.50	4.5–9.0
				62.5	2.50	0.70	
				125	1.60	0.35	

8.6 Z Correction Factors

Temp. (°C)	Air Pressure (kPa)						
	80	85	90	95	100	101.3	105
18.0	1.0022	1.0023	1.0023	1.0024	1.0025	1.0025	1.0025
18.5	1.0023	1.0024	1.0024	1.0025	1.0025	1.0026	1.0026
19.0	1.0024	1.0025	1.0025	1.0026	1.0026	1.0027	1.0027
19.5	1.0025	1.0026	1.0026	1.0027	1.0027	1.0028	1.0028
20.0	1.0026	1.0027	1.0027	1.0028	1.0028	1.0029	1.0029
20.5	1.0027	1.0028	1.0028	1.0029	1.0029	1.0030	1.0030
21.0	1.0028	1.0029	1.0029	1.0030	1.0031	1.0031	1.0031
21.5	1.0030	1.0030	1.0031	1.0031	1.0032	1.0032	1.0032
22.0	1.0031	1.0031	1.0032	1.0032	1.0033	1.0033	1.0033
22.5	1.0032	1.0032	1.0033	1.0033	1.0034	1.0034	1.0034
23.0	1.0033	1.0033	1.0034	1.0034	1.0035	1.0035	1.0036
23.5	1.0034	1.0035	1.0035	1.0036	1.0036	1.0036	1.0037
24.0	1.0035	1.0036	1.0036	1.0037	1.0037	1.0038	1.0038
24.5	1.0037	1.0037	1.0038	1.0038	1.0039	1.0039	1.0039

Z values in microliters per milligram

9 Accessories

9.1 Accessories

Charging options and Bluetooth	Part No.
Mains adapter for electronic pipettes	4200
Pipette Li-ion battery	4205
Single pipette charging stand, incl. mains adapter	4210
Charging/communication stand for 1 pipette, incl. mains adapter	4211
Carousel charging stand for 4 pipettes, incl. mains Adapter	4215
Linear stand, holds up to 4 charging stations	3215
Mains adapter for linear stand and carousel charging stand	3216
Charging station for linear stand (incl. connection cable)	3217
Charging/communication station for linear stand (incl. connection cable and USB cable)	3218
Bluetooth module for VIAFLO/VOYAGER	4221
Bluetooth PC module with PC software	4225
General	Part No.
ASSIST personal pipetting assistant	4500
ASSIST PLUS pipetting robot	4505
O-ring removal tool (300 µl and 1250 µl, plastic)	161916

9.2 Consumables

Red O-rings for tip fittings		Part No.
300 µl	Replacement kit 24/pack	100-00027-50
1250 µl	Replacement kit 24/pack	100-00028-50
5000 µl	Replacement kit 10/pack	100-00029-00

O-Ring and Seal Assembly		Part No.
12.5 µl	O-Ring (black)	300-00158-00
12.5 µl	Seal (white)	161922
50 µl	Flange (black)	161927
50 µl	Seal (white)	161928
125 µl	O-Ring (black)	300-00159-00
125 µl	Seal (white)	161924
300 µl	O-Ring (black)	300-00160-00
300 µl	Seal (white)	301-00157-01
1250 µl	Cup Seal (black)	301-00177-00
5000 µl	Cup Seal (white)	130-00192-00

Lubricant for VIAFLO pipettes and O-rings		Part No.
Lube	Parker Super-O-Lube, Silicone based, 50 g / 2 oz, for single channel 1250 µl and 5000 µl pipettes	100-00135-50
Grease	Grease Nye Fluorocarbon Gel 807, 5 g / 0.2 oz, for single channel 12.5 µl, 125 µl and 300 µl pipettes	100-00136-50

10 ml Disposable Reagent Reservoirs		Part No.
10 ml	Reservoir Base, 10 pack	4306
Polystyrene	30 reservoirs individually sealed, sterile, 1 base per case	4331
	Four sleeves of 50 reservoirs, 200 reservoirs per case, sterile, 1 base per case	4332
Polypropylene	30 reservoirs individually sealed, sterile, 1 base per case	4336
	Four sleeves of 50 reservoirs, 200 reservoirs per case, sterile, 1 base per case	4337

25 ml Disposable Reagent Reservoirs		Part No.
25 ml	Reservoir Base, 10 pack	4304
Polystyrene	30 reservoirs individually sealed, sterile, 1 base per case	4311
	Four sleeves of 50 reservoirs, 200 reservoirs per case, sterile, 1 base per case	4312
Polystyrene, divided	Trial pack, sterile	4350
	30 reservoirs individually sealed, sterile, 1 base per case	4351
	Four sleeves of 50 reservoirs, 200 reservoirs per case, sterile, 1 base per case	4352
Polypropylene	30 reservoirs individually sealed, sterile, 1 base per case	4316
	Four sleeves of 50 reservoirs, 200 reservoirs per case, sterile, 1 base per case	4317
	Trial pack, sterile	4355
Polypropylene, divided	30 reservoirs individually sealed, sterile, 1 base per case	4356
	Four sleeves of 50 reservoirs, 200 reservoirs per case, sterile, 1 base per case	4357

100 ml Disposable Reagent Reservoirs		Part No.
100 ml	Reservoir Base, 10 pack	4305
Polystyrene	30 reservoirs individually sealed, sterile, 1 base per case	4321
	Four sleeves of 50 reservoirs, 200 reservoirs per case, sterile, 1 base per case	4322
Polypropylene	30 reservoirs individually sealed, sterile, 1 base per case	4326
	Four sleeves of 50 reservoirs, 200 reservoirs per case, sterile, 1 base per case	4327

GripTips for all INTEGRA Pipettes		Part No.
Purple:	Bulk pack, 1 bag of 1000 tips, non-sterile	4411
12.5 µl	5 inserts of 384 tips, non-sterile, GREEN CHOICE	4412
	5 racks of 384 tips, non-sterile	4413
	5 racks of 384 tips, sterile	4414
	5 racks of 384 tips, sterile, filter	4415
	5 inserts of 384 tips, pre-sterilized, GREEN CHOICE	4416
	Bulk pack, 1 bag of 1000 tips, non-sterile, LONG	4401
	5 inserts of 384 tips, non-sterile, LONG, GREEN CHOICE	4402
	5 racks of 384 tips, non-sterile, LONG	4403
	5 racks of 384 tips, sterile, LONG	4404
	5 racks of 384 tips, sterile, filter, LONG	4405
	5 inserts of 384 tips, pre-sterilized, LONG, GREEN CHOICE	4406
	5 XYZ racks of 384 tips, sterile, filter, SHORT	6475
Purple:	5 racks of 384 tips, non-sterile	6553
12.5 µl	5 racks of 384 tips, sterile	6554
low	5 racks of 384 tips, sterile, filter	6555
retention	5 racks of 384 tips, non-sterile, LONG	6503
	5 racks of 384 tips, sterile, LONG	6504
	5 racks of 384 tips, sterile, filter, LONG	6505
Yellow:	Bulk pack, 1 bag of 1000 tips, non-sterile	4421
50 µl,	5 inserts of 384 tips, non-sterile, GREEN CHOICE	4422
125 µl	5 racks of 384 tips, non-sterile	4423
	5 racks of 384 tips, sterile	4424
	5 racks of 384 tips, sterile, filter	4425
	5 inserts of 384 tips, pre-sterilized, GREEN CHOICE	4426
Yellow:	5 racks of 384 tips, non-sterile	6563
50 µl,	5 racks of 384 tips, sterile	6564
125 µl	5 racks of 384 tips, sterile, filter	6565
low		
retention		

GripTips for all INTEGRA Pipettes		Part No.
Green:	Bulk pack, 1 bag of 1000 tips, non-sterile	4431
300 μ l	5 inserts of 96 tips, non-sterile, GREEN CHOICE	4432
	5 racks of 96 tips, non-sterile	4433
	5 racks of 96 tips, sterile	4434
	5 racks of 96 tips, sterile, filter	4435
	5 inserts of 96 tips, pre-sterilized, GREEN CHOICE	4436
	Bulk pack, 1 bag of 1000 tips, non-sterile, LONG	4481
	5 inserts of 96 tips, non-sterile, LONG, GREEN CHOICE	4482
	5 racks of 96 tips, non-sterile, LONG	4483
	5 racks of 96 tips, sterile, LONG	4484
	5 racks of 96 tips, sterile, filter, LONG	4485
	5 inserts of 96 tips, pre-sterilized, LONG, GREEN CHOICE	4486
	5 racks of 96 tips, non-sterile, WIDE BORE	6633
	5 racks of 96 tips, sterile, WIDE BORE	6634
	5 racks of 96 tips, sterile, filter, WIDE BORE	6635
	Green:	5 racks of 96 tips, non-sterile
300 μ l low retention	5 racks of 96 tips, sterile	6534
	5 racks of 96 tips, sterile, filter	6535
Blue:	Bulk pack, 1 bag of 500 tips, non-sterile	4441
1250 μ l	5 inserts of 96 tips, non-sterile, GREEN CHOICE	4442
	5 racks of 96 Tips, non-sterile	4443
	5 racks of 96 Tips, sterile	4444
	5 racks of 96 Tips, sterile, filter	4445
	5 inserts of 96 tips, pre-sterilized, GREEN CHOICE	4446
	5 racks of 96 tips, non-sterile, WIDE BORE	6643
	5 racks of 96 tips, sterile, WIDE BORE	6644
	5 racks of 96 tips, sterile, filter, WIDE BORE	6645
Blue:	5 racks of 96 tips, non-sterile	6543
1250 μ l low retention	5 racks of 96 tips, sterile	6544
	5 racks of 96 tips, sterile, filter	6545

GripTips for all INTEGRA Pipettes		Part No.
Orange:	Bulk pack, 1 bag of 250 tips, non-sterile	4451
5 ml	5 racks of 48 Tips, non-sterile	4453
	5 racks of 48 Tips, sterile	4454
	5 racks of 48 Tips, sterile, filter	4455
	Individually wrapped, 100 tips per case, sterile	4456
